

Jednościenne przewody kominowe typu **SPU**

PRZEZNACZENIE:

stosowany jako wkład do istniejących szachtów w celu odprowadzenia spalin z urządzeń grzewczych opalanych gazem lub olejem opałowym o maksymalnej temperaturze spalin 600 °C

BUDOWA RUR I KSZTAŁTEK:

elementy jednościenne,

ZAKRES ŚREDNIC:

80 ÷ 500 mm

PALIWO:

gaz lub olej opałowy

GATUNEK I GRUBOŚĆ MATERIAŁU:

stal nierdzewna o grubości 0,5 ÷ 0,8 mm – 1.4301

ODPORNOŚĆ NA KORYZJĘ:

Vm/V2/V3

ODPORNOŚĆ NA POŻAR I SADZY:

Odporny

ODLEGŁOŚĆ OD MATERIAŁÓW PALNYCH:

250 mm

KLASA TEMPERATURY:

T 600 - 600 stopni °C

SPOSÓB PRACY KOMINA:

podciśnieniowy

ODPORNOŚĆ NA DZIAŁANIE KONDENSATU:

W/D

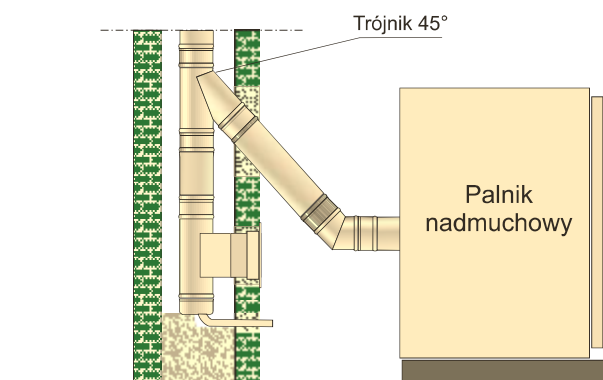

PARASOL

101

d	A	C	INDEX
80	130	180	101080000
100	130	180	101100000
113	130	180	101110000
120	130	180	101120000
130	130	180	101130000
140	130	250	101140000
150	130	250	101150000
160	190	250	101160000
180	190	300	101180000
200	190	d+100	101200000
225	190	d+100	101220000
250	190	d+100	101250000
300	230	d+100	101300000
350	230	d+100	101350000
400	230	d+100	101400000
450	230	d+100	101450000
500	230	d+100	101500000

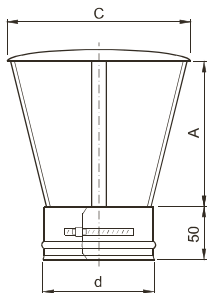

PŁYTA DACHOWA

102

d	A	B	INDEX
80	320	93	102080000
100	320	93	102100000
113	320	93	102110000
120	320	93	102120000
130	320	93	102130000
140	320	93	102140000
150	330	93	102150000
160	330	150	102160000
180	400	150	102180000
200	400	150	102200000
225	400	150	102220000
250	450	150	102250000
300	500	150	102300000
350	550	150	102350000
400	600	150	102400000
450	650	150	102450000
500	700	150	102500000

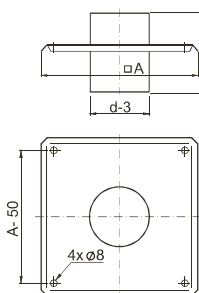

RURA

103, 104, 105, 106

d	INDEX			
	L 1000	L 500	L 330	L 250
80	103080000	104080000	105080000	106080000
100	103100000	104100000	105100000	106100000
113	103110000	104110000	105110000	106110000
120	103120000	104120000	105120000	106120000
130	103130000	104130000	105130000	106130000
140	103140000	104140000	105140000	106140000
150	103150000	104150000	105150000	106150000
160	103160000	104160000	105160000	106160000
180	103180000	104180000	105180000	106180000
200	103200000	104200000	105200000	106200000
225	103220000	104220000	105220000	106220000
250	103250000	104250000	105250000	106250000
300	103300000	104300000	105300000	106300000
350	103350000	104350000	105350000	106350000
400	103400000	104400000	105400000	106400000
450	103450000	104450000	105450000	106450000
500	103500000	104500000	105500000	106500000



TRÓJNIK 90°

107

d	L	INDEX
80	250	107080000
100	250	107100000
113	333	107110000
120	333	107120000
130	333	107130000
140	333	107140000
150	333	107150000
160	400	107160000
180	400	107180000
200	400	107200000
225	450	107220000
250	450	107250000
300	500	107300000
350	550	107350000
400	600	107400000
450	650	107450000
500	700	107500000

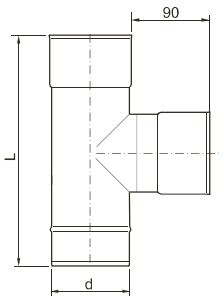

TRÓJNIK REDUKCYJNY

108

d	L	xyz	INDEX
80	250		108080xyz
100	250		108100xyz
113	333		108110xyz
120	333		108120xyz
130	333		108130xyz
140	333		108140xyz
150	333		108150xyz
160	400		108160xyz
180	400		108180xyz
200	400		108200xyz
225	450		108220xyz
250	450		108250xyz
300	500		108300xyz
350	550		108350xyz
400	600		108400xyz
450	650		108450xyz
500	700		108500xyz

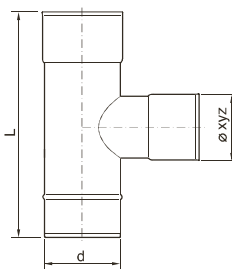

Przykład:
Trójnik redukcyjny 130/120, d=130, xyz=120, indeks: 108130120

TRÓJNIK 45

109

d	A	L	INDEX
80	165	250	109080000
100	215	333	109100000
113	225	333	109110000
120	225	333	109120000
130	245	360	109130000
140	260	380	109140000
150	270	400	109150000
160	280	400	109160000
180	310	430	109180000
200	350	497	109200000
225	400	560	109220000
250	410	560	109250000
300	500	690	109300000
350	540	730	109350000
400	620	900	109400000
450	700	900	109450000
500	780	1000	109500000

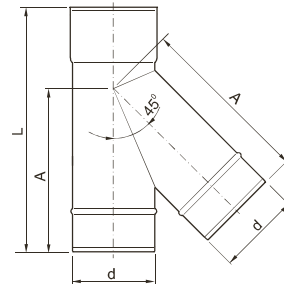

TRÓJNIK POD REG. CIĄGU

110

d	INDEX
150	110150000
160	110160000
180	110180000
200	110200000
225	110220000
250	110250000
300	110300000
350	110350000
400	110400000
450	110450000
500	110500000

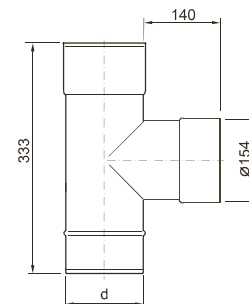

WYCZYSTKA

111

d	L	INDEX
80	333	111080000
100	333	111100000
113	333	111110000
120	333	111120000
130	333	111130000
140	333	111140000
150	333	111150000
160	400	111160000
180	400	111180000
200	400	111200000
225	400	111220000
250	400	111250000
300	500	111300000
350	500	111350000
400	500	111400000
450	500	111450000
500	500	111500000

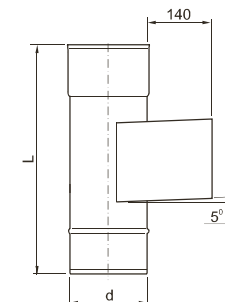

WYCZYSTKA OKRĄGŁA

112

d	L	INDEX
80	250	112080000
100	250	112100000
113	250	112110000
120	250	112120000
130	333	112130000
140	333	112140000
150	333	112150000
160	400	112160000
180	400	112180000
200	400	112200000
225	400	112220000
250	400	112250000
300	500	112300000
350	500	112350000
400	500	112400000
450	500	112450000
500	500	112500000

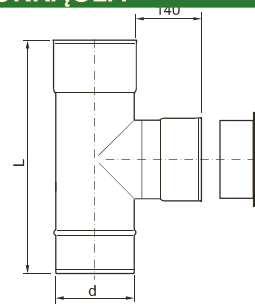

ODSKRAPLACZ A

114

d	INDEX
113	114110000
120	114120000
130	114130000

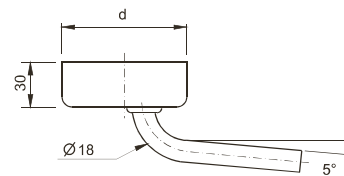

KOLANO 45

115

d	A	INDEX
80	105	115080000
100	110	115100000
113	115	115110000
120	115	115120000
130	120	115130000
140	120	115140000
150	120	115150000
160	125	115160000
180	130	115180000
200	140	115200000
225	160	115220000
250	165	115250000
300	180	115300000
350	190	115350000
400	215	115400000
Stal		
450	225	115450000
500	235	115500000

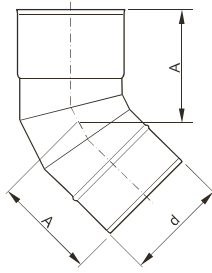

KOLANO 90

116

d	A	INDEX
80	130	116080000
100	140	116100000
113	160	116110000
120	160	116120000
130	185	116130000
140	185	116140000
150	185	116150000
160	185	116160000
180	200	116180000
200	200	116200000
225	200	116220000
250	235	116250000
300	270	116300000
350	320	116350000
400	340	116400000
Stal		
450	390	116450000
500	430	116500000

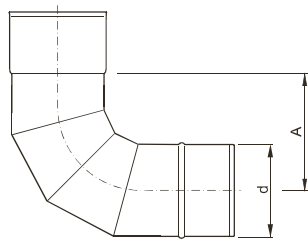

KOLANO Z WYCZYTKĄ

118

d	A	INDEX
80	145	118080000
100	145	118100000
113	170	118110000
120	175	118120000
130	180	118130000
140	180	118140000
150	180	118150000
160	190	118160000
180	200	118180000
200	220	118200000
225	220	118220000
250	250	118250000
300	285	118300000
350	330	118350000
400	355	118400000
Stal		
450	400	118450000
500	440	118500000

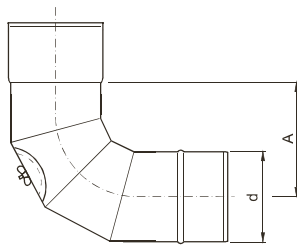

TELESKOP

121

d	INDEX
80	121080000
100	121100000
113	121110000
120	121120000
130	121130000
140	121140000
150	121150000
160	121160000
180	121180000
200	121200000
225	121220000
250	121250000
300	121300000
350	121350000
400	121400000
450	121450000
500	121500000

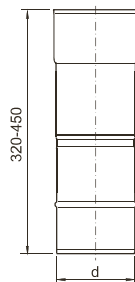

KRÓCIEC POMIAROWY 25

122

d	INDEX
80	122080000
100	122100000
113	122110000
120	122120000
130	122130000
140	122140000
150	122150000
160	122160000
180	122180000
200	122200000
225	122220000
250	122250000
300	122300000
350	122350000
400	122400000
450	122450000
500	122500000

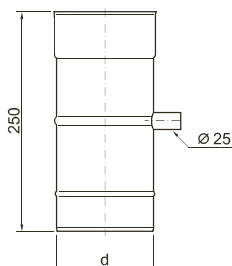

KRÓCIEC POMIAROWY 64

123

d	INDEX
200	123200000
225	123220000
250	123250000
300	123300000
350	123350000
400	123400000
450	123450000
500	123500000

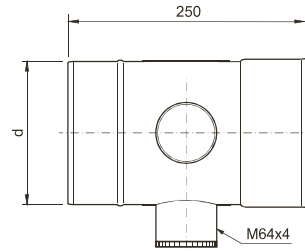

PODPORA PRZEJŚCIOWA

124

d	A	B	N	INDEX
80	230	250	140	124080000
100	230	250	140	124100000
113	230	250	140	124110000
120	230	250	140	124120000
130	230	250	140	124130000
140	230	250	140	124140000
150	230	250	140	124150000
160	230	250	190	124160000
180	300	300	190	124180000
200	300	300	190	124200000
225	300	300	190	124220000
250	d+100	d+100	190	124250000
300	d+100	d+100	190	124300000
350	d+100	d+100	190	124350000
400	d+100	d+100	190	124400000
450	d+100	d+100	190	124450000
500	d+100	d+100	190	124500000

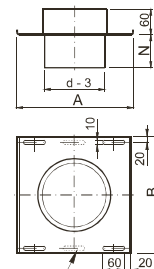

Dotychczasowy otwór dla d>300

REDUKCJA

125

d	xyz	INDEX
80		125080xyz
100		125100xyz
113		125110xyz
120		125120xyz
130		125130xyz
140		125140xyz
150		125150xyz
160		125160xyz
180		125180xyz
200		125200xyz
225		125220xyz
250		125250xyz
300		125300xyz
350		125350xyz
400		125400xyz
450		125450xyz
500		125500xyz
zgodnie z zamówieniem		

UWAGA: Wykonujemy tylko, jeżeli nie można wykonać metoda rozciągania

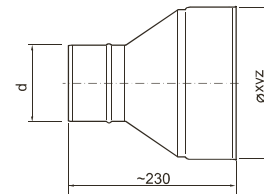

Przykład: Redukcja 113/120, d=113, xyz=120, index=125110120

REDUKCJA ODWROTNA

126

d	xyz	INDEX
80		126080xyz
100		126100xyz
113		126110xyz
120		126120xyz
130		126130xyz
140		126140xyz
150		126150xyz
160		126160xyz
180		126180xyz
200		126200xyz
225		126220xyz
250		126250xyz
300		126300xyz
350		126350xyz
400		126400xyz
450		126450xyz
500		126500xyz
zgodnie z zamówieniem		

UWAGA: Wykonujemy tylko, jeżeli nie można wykonać metoda rozciągania

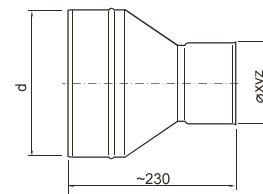

Przykład: Redukcja 120/113, d=120, xyz=113, index=126120113

ZŁĄCZKA DWUKIELICHOWA

127

d	INDEX
80	127080000
100	127100000
113	127110000
120	127120000
130	127130000
140	127140000
150	127150000
160	127160000
180	127180000
200	127200000
225	127220000
250	127250000
300	127300000
350	127350000
400	127400000
450	127450000
500	127500000

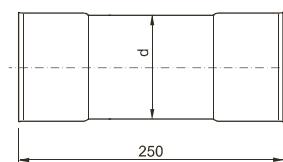

S
P
U

ZŁĄCZKA DWUNYFLOWA 128

d	INDEX
80	128080000
100	128100000
113	128110000
120	128120000
130	128130000
140	128140000
150	128150000
160	128160000
180	128180000
200	128200000
225	128220000
250	128250000
300	128300000
350	128350000
400	128400000
450	128450000
500	128500000

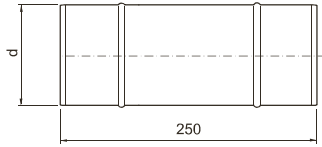

OBEJMA DO MURU 129

d	INDEX
80	129080000
100	129100000
113	129110000
120	129120000
130	129130000
140	129140000
150	129150000
160	129160000
180	129180000

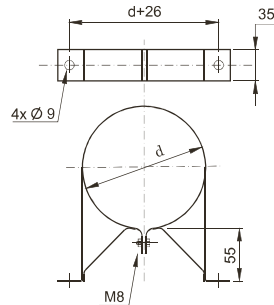

OBEJMA DYSTANSOWA 130

d	INDEX
80	130080000
100	130100000
113	130110000
120	130120000
130	130130000
140	130140000
150	130150000
160	130160000
180	130180000
200	130200000
225	130220000
250	130250000
300	130300000
350	130350000
400	130400000
450	130450000
500	130500000

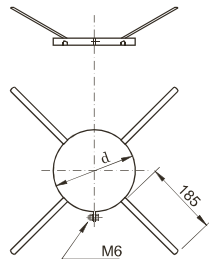

DRZWICZKI 131

INDEX
131010000

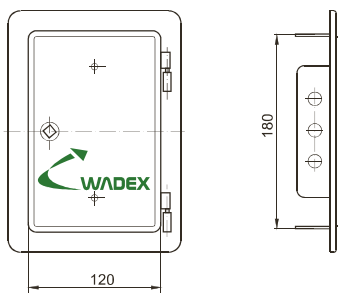

PRZEDŁUŻKA WYCZYSTKI 132

L	INDEX
250	132010000
500	132020000
1000	132030000

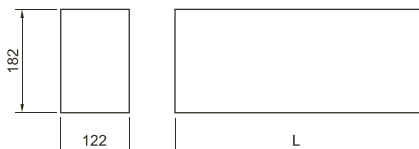

ZATYCZKA OKRĄGŁA 134

d	INDEX
80	134080000
100	134100000
113	134110000
120	134120000
130	134130000
140	134140000
150	134150000
160	134160000
180	134180000
200	134200000
225	134220000
250	134250000
300	134300000
350	134350000
400	134400000
450	134450000
500	134500000

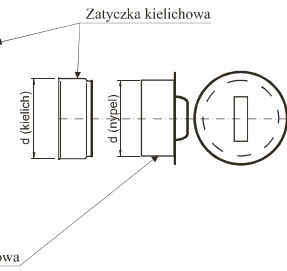

ZATYCZKA PERFOROWANA 134

d	INDEX
80	134080100
100	134100100
113	134110100
120	134120100
130	134130100
140	134140100
150	134150100
160	134160100
180	134180100
200	134200100
225	134220100
250	134250100
300	134300100
350	134350100

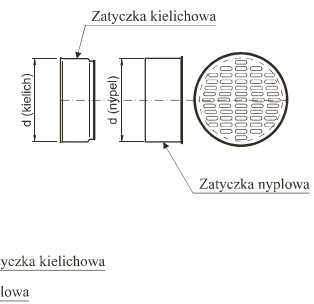

OBEJMA ZWYKŁA 136

d	INDEX
80	136080000
100	136100000
113	136110000
120	136120000
130	136130000
140	136140000
150	136150000
160	136160000
180	136180000
200	136200000
225	136220000
250	136250000
300	136300000
350	136350000
400	136400000
450	136450000
500	136500000

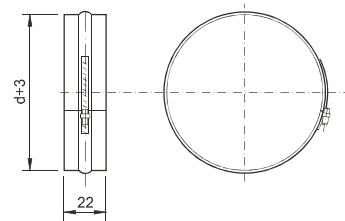

KOLANO 45 /spawane/ 138

d	A	INDEX
80	90	138080000
100	110	138100000
113	120	138110000
120	120	138120000
130	120	138130000
140	120	138140000
150	120	138150000
160	120	138160000
180	130	138180000
200	140	138200000
225	160	138220000
250	160	138250000
300	170	138300000
350	180	138350000

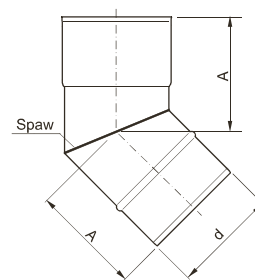

KOLANO 90 /spawane/

139

d	A	INDEX
80	115	139080000
100	115	139100000
113	115	139110000
120	135	139120000
130	135	139130000
140	135	139140000
150	150	139150000
160	155	139160000
180	165	139180000
200	180	139200000
225	180	139220000
250	210	139250000
300	235	139300000
350	270	139350000

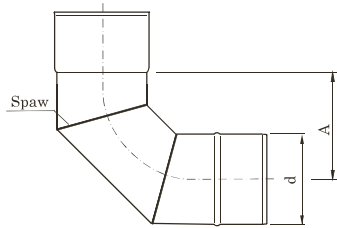

REDUKCJA SKOKOWA

144

d	xyz	INDEX
80		144080xyz
100		144100xyz
113		144110xyz
120		144120xyz
130		144130xyz
140		144140xyz
150		144150xyz
160		144160xyz
180		144180xyz
200		144200xyz
225		144220xyz
250		144250xyz

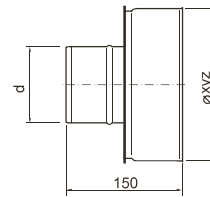

Przykład:
Redukcja 113/120, d=113, xyz=120, index=144110120

TRÓJNIK 45° redukcyjny

140

d	d1	A	L	INDEX
80	207	250	140080xyz	
100	215	333	140100xyz	
113	225	333	140110xyz	
120	225	333	140120xyz	
130	245	360	140130xyz	
140	260	380	140140xyz	
150	270	400	140150xyz	
160	280	400	140160xyz	
180	310	430	140180xyz	
200	350	497	140200xyz	
225	400	560	140220xyz	
250	410	560	140250xyz	
300	500	690	140300xyz	
350	540	730	140350xyz	
400	620	900	140400xyz	
450	700	900	140450xyz	
500	780	1000	140500xyz	

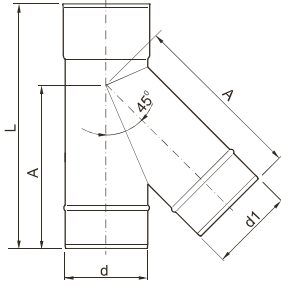

Przykład: Trójnik red. 45° 120/113, d=120, xyz=113, index=140120113

REDUKCJA OKRĄGŁA POD REGULATOR CIĄGU

141

d	INDEX
80	141080000
100	141100000
113	141110000
120	141120000
130	141130000
140	141140000

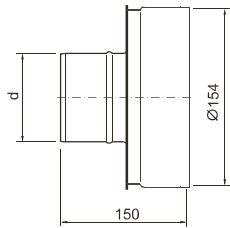

ODSKRAPLACZ B

147

d	G	INDEX
80	70	147080000
100	70	147100000
140	70	147140000
150	70	147150000
160	80	147160000
180	80	147180000
200	80	147200000
225	80	147220000
250	80	147250000
300	80	147300000
350	80	147350000
400	80	147400000
450	80	147450000
500	80	147500000

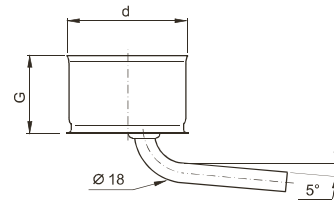

REDUKCJA PROSTOKĄTNA POD REGULATOR CIĄGU

142

INDEX
142000000

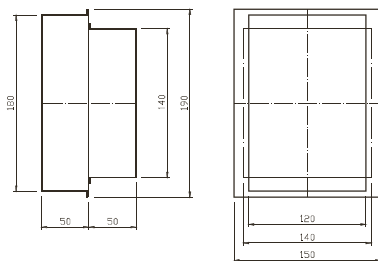

ODSKRAPLACZ "A" Z PODST.

150

d	INDEX
113	150110000
120	150120000
130	150130000

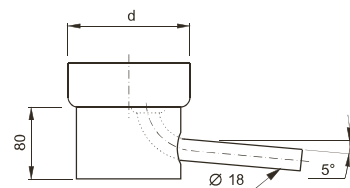

REDUKCJA ROZCIĄGANA

143

d	xyz	INDEX
100		143100xyz
113		143110xyz
120		143120xyz
130		143130xyz
140		143140xyz
150		143150xyz
160		143160xyz
180		143180xyz
200		143200xyz
225		143220xyz
250		143250xyz

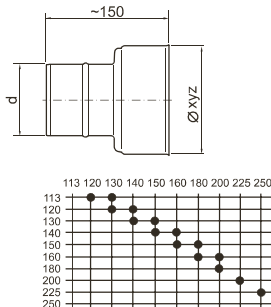

Przykład:
Redukcja 113/120, d=113, xyz=120, index=143110120

ODSKRAPLACZ "B" Z PODST.

151

d	INDEX
80	151080000
100	151100000
140	151140000
150	151150000
160	151160000
180	151180000
200	151200000
225	151220000
250	151250000
300	151300000
350	151350000
400	151400000
450	151450000
500	151500000

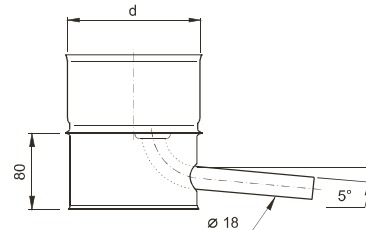

SPU

REDUKCJA ROZCIĄGANA ODWROTNA 153

d	xyz	INDEX
100		153100xyz
113		153110xyz
120		153120xyz
130		153130xyz
140		153140xyz
150		153150xyz
160		153160xyz
180		153180xyz
200		153200xyz
225		153220xyz
250		153250xyz

zgodnie z zamówieniem

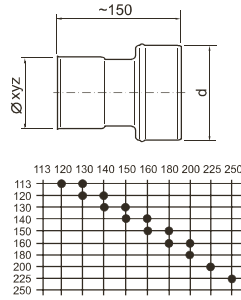

Przykład: Redukcja 120/113, d=120, xyz=113, index=153120110

REDUKCJA DWUNYPLOWA 158

d	xyz	INDEX
80		158080xyz
100		158100xyz
113		158110xyz
120		158120xyz
130		158130xyz
140		158140xyz
150		158150xyz
160		158160xyz
180		158180xyz
200		158200xyz
225		158220xyz
250		158250xyz
300		158300xyz
350		158350xyz
400		158400xyz
450		158450xyz
500		158500xyz

zgodnie z zamówieniem

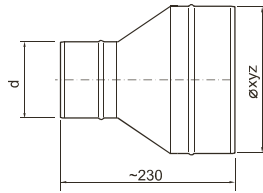

Przykład: Redukcja 120N/130N, d=120, xyz=130, index=158120130

REDUKCJA DWUKIELICHOWA 159

d	xyz	INDEX
80		159080xyz
100		159100xyz
113		159110xyz
120		159120xyz
130		159130xyz
140		159140xyz
150		159150xyz
160		159160xyz
180		159180xyz
200		159200xyz
225		159220xyz
250		159250xyz
300		159300xyz
350		159350xyz
400		159400xyz
450		159450xyz
500		159500xyz

zgodnie z zamówieniem

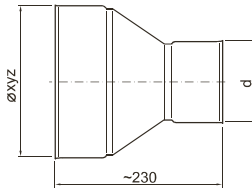

Przykład: Redukcja 120K/130K, d=120, xyz=130, index=159120130

ODSKRAPLACZ PRZELOTOWY PIONOWY 160

d	INDEKS
80	160080000
100	160100000
113	160110000
120	160120000
130	160130000
140	160140000
150	160150000
160	160160000
180	160180000
200	160200000
225	160220000
250	160250000
300	160300000
350	160350000
400	160400000
450	160450000
500	160500000

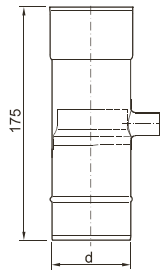

PAKIET KSZTAŁTEK 120

d	h	INDEX
113	330	120110000
120	330	120120000
130	330	120130000
140	330	120140000
150	330	120150000
160	330	120160000
180	500	120180000
200	500	120200000

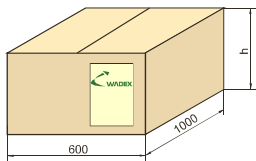

Nazwa	szt.	Nr
PARASOL	1	101
PLYTA DACHOWA	1	102
TROJNIK 90°	1	107
WYCZYSTKA	1	111
ODSKRAPLACZ	1	114 lub 147
DRZWICZKI	1	131

REGULATOR CIĄGU PROST. 001

INDEX
001000001

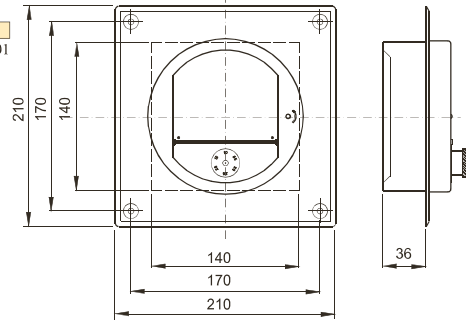

REGULATOR CIĄGU OKRĄGŁY 002

INDEX
002000001

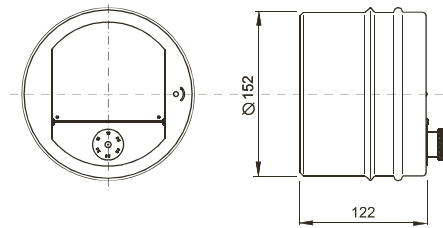

PORTKI KOMINOWE 999

d	d1	A	C	INDEX
80				999
100				
113				
120				
130				
140				
150				
160				
180				
200				
225				
250				
300				
350				
400				
450				
500				

wytniany wg zamówienia

wytniany wg zamówienia

wytniany wg zamówienia

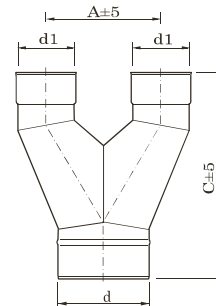

PAKIET SPU 119

d	INDEX
113	119110000
120	119120000
130	119130000
140	119140000
150	119150000

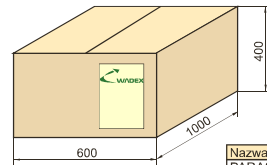

Nazwa	szt.	Nr
PARASOL	1	101
PLYTA DACHOWA	1	102
RURA 1000 mm	6	103
RURA 500 mm	1	104
RURA 250 mm	1	106
TROJNIK 90°	1	107
WYCZYSTKA	1	111
ODSKRAPLACZ	1	114 lub 147
DRZWICZKI	1	131

System SPU o przekroju owalnym

PARASOL owalny 101

A	B	C	INDEX
100	200	300	1011000006
120	180	300	1011800006
120	240	350	1011200006
140	250	350	1011400006

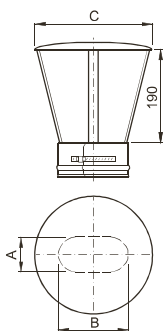

PŁYTA DACHOWA owalna 102

A	B	C	INDEX
100	200	400	1021000006
120	180	400	1021800006
120	240	450	1021200006
140	250	450	1021400006

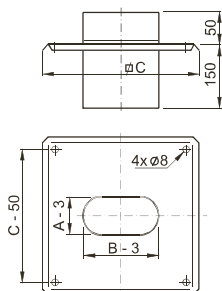

RURA owalna 103, 104, 106

INDEX					
A	B	L 1000	L 500	L 250	
100	200	1031000006	1041000006	1061000006	
120	180	1031800006	1041800006	1061800006	
120	240	1031200006	1041200006	1061200006	
140	250	1031400006	1041400006	1061400006	

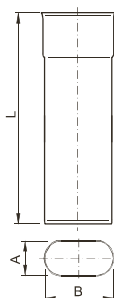

TRÓJNIK 90° owalny 107

A	B	d	L	INDEX
100	200	150	333	1071000006
120	180	150	333	1071800006
120	240	180	400	1071200006
140	250	200	400	1071400006

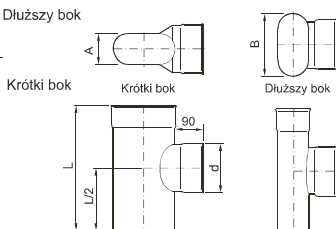

TRÓJNIK 90° redukcyjny owalny 108

A	B	d1	L	INDEX
100	200	130	333	10810013Z6
100	200	160	400	10810016Z6
100	200	180	400	10810018Z6
100	200	200	400	10810020Z6
120	180	130	333	10818013Z6
120	180	160	400	10818016Z6
120	180	180	400	10818018Z6
120	180	200	400	10818020Z6
120	240	150	333	10812015Z6
120	240	160	400	10812016Z6
120	240	200	400	10812020Z6

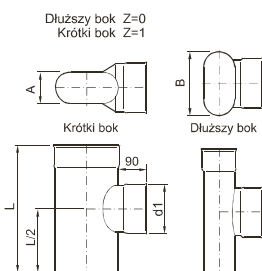

WYCZYSTKA owalna 111

A	B	INDEX
100	200	1111000006
120	180	1111800006
120	240	1111200006
140	250	1111400006

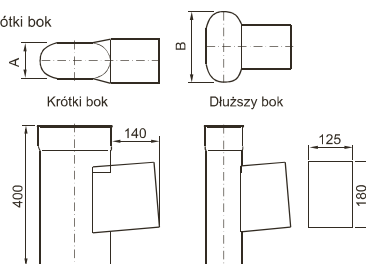

KOLANO 45° owalne 115

A	B	C	INDEX
100	200	180	1151000006
120	180	180	1151800006
120	240	180	1151200006
140	250	190	1151400006

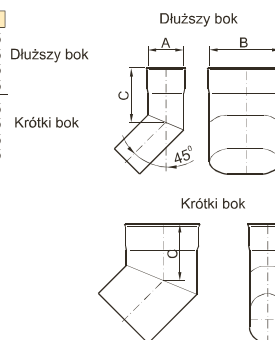

KOLANO 90° owalne 117

A	B	C	INDEX
100	200	174	1171000006
120	180	174	1171800006
120	240	172	1171200006
140	250	182	1171400006

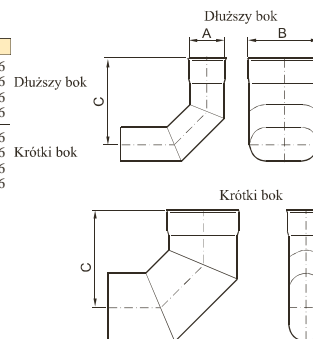

ODSKRAPLACZ owalny 147

A	B	INDEX
100	200	1471000006
120	180	1471800006
120	240	1471200006
140	250	1471400006

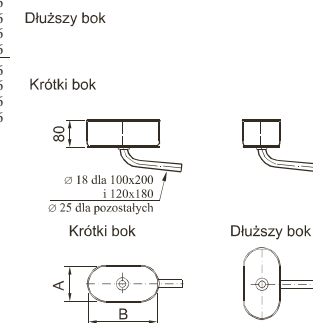

ELEMENT NIETYPOWY

Elementy niekatalogowe wykonywane są na podstawie rysunków dostarczonych przez klienta. Wycena takich elementów jest oparta na indywidualnej kalkulacji.

999

SPU