

Odkryj
**BOGACTWO
FORM,
ZNAJDŹ SWÓJ
ULUBIONY *styl!***



 **domino**[®]



KATALOG
KLAMEK
2017

Rodzaje dostępnych klamek



Klamki na **dzielonym szyldzie kwadratowym**
s. 18



Klamki na **dzielonym szyldzie okrągłym**
s. 41



Klamki na **długim szyldzie**
s. 69



Klamki ze **stali nierdzewnej**
s. 79



Klamki na **dzielonym szyldzie slim**
s. 83



Szyldy
s. 87



Gałki
s. 94



Klamki do **drzwi zewnętrznych**
s. 98



Klamki **bramowe**
s. 104



Klamki **okienne**
s. 108



Aksesoria
s. 110

Oznaczenia



Rodzaj szyldu

BB - klucz
PZ - wkładka bębnekowa
WC - łazienka

Formy przebić

BB - klucz
PZ - wkładka bębnekowa
B/O - bez otworu
WC - łazienka
lewa/prawa - strona



ZARZĄDZANIE JAKOŚCIĄ

Jesteśmy certyfikowani
według wymagań
ISO 9001:2008

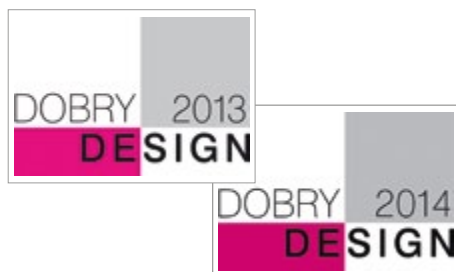

KLAMKA INFINITA

Nagroda w konkursie Dobry Design 2013
organizowanym przez wydawcę magazynu
„Dobrze Mieszkaj” – Publikator Sp. z o.o.



Jesteśmy w elitarnym gronie najdynamiczniej
rozwijających się małych i średnich firm na rynku
e-commerce w Polsce.



Posiadamy Certyfikat Jakości Biznesu, którego
celem jest m.in. propagowanie idei etycznego
postępowania w relacjach biznesowych.

Szanowni Państwo,

chcieliśmy zaprosić Państwa do świata naszych klamek, w którym
dominuje różnorodność stylów, z zachowaniem bezpieczeństwa
i najwyższej jakości.

W katalogu zamieściliśmy zarówno klasyczne, jak i nowoczesne
wzory okuć drzwiowych, aby dać Państwu możliwość komfortowej
aranżacji wnętrz. Bazując na naszym wieloletnim doświadczeniu i opinii
dziesiątek klientów, stworzyliśmy ofertę, kreując tym samym trendy
we wzornictwie klamek.

Niebanalny design znajdą Państwo w każdej z naszych klamek do drzwi.
Oferujemy dużą różnorodność wśród kolorów, rodzajów i kształtów.
Wykonane one zostały z mosiądzu, aluminium lub stali nierdzewnej
i znanu, a szlifowanie i poddanie obróbce galwanicznej, dodało im
odporności na ścieranie oraz unikalne właściwości kolorystyczne i efekty
estetyczne.

Naszą ofertę uzupełniliśmy o wizjery, zawiasy, zamki, wkładki, odbojniki,
tuleje do drzwi łazienkowych i wiele innych elementów z zakresu okuć
drzwiowych, produkowanych przez renomowane firmy zachodnie.

Wszystkie klamki dostępne w Domino posiadają certyfikat zgodności
z PN EN 1906, wydany przez Instytut Techniki Budowlanej w Poznaniu,
uprawniający do ich stosowania w budownictwie.

Gwarantujemy Państwu terminowość dostaw, fachowe doradztwo
i najwyższą jakość produktów.

Nasze klamki otwierają każde drzwi, także te do wyobraźni!

Serdecznie zapraszamy!

Zofia i Eugeniusz Świszcz
Domino Polska



Biuro przy ul. Rzeźniczej w Dzierżonowie



SALON W DZIERŻONIOWIE
ul. Rzeźnicza 4, Dzierżonów

Godziny otwarcia:

od poniedziałku - do piątku: 8:00 - 18:00
sobota: 9:00 - 16:00

Dane kontaktowe:

tel. 74 832 48 03
fax. 74 832 48 04
kom: 609 830 666
e-mail: detal@domino.pl



SALON W LUBINIE
ul. Legnicka 69 B, Lubin

Godziny otwarcia:

od poniedziałku - do piątku: 9:00 - 19:00
sobota: 9:00 - 16:00

Dane kontaktowe:

tel. 74 832 48 71
tel. 74 832 34 04
kom: 885 552 355
e-mail: lubin@domino.pl



Lekkość *elegancji*

Solidność i delikatność, choć wydają się nie mieć ze sobą wiele wspólnego, znajdują często niezwykle połączenie w designie.

KLAMKA ENIGMA-R



KLAMKA ENIGMA-R
M6/ M9



KLAMKA ENIGMA-R
M3

Ekspresja formy

Stworzona z myślą o zwolennikach minimalizmu i geometrycznego designu. Dzięki prostej formie pasuje do wnętrz o nowoczesnym charakterze. Dwa kolory antracyt/ chrom idealnie dopełniają jej kwadratowe kształty.

KLAMKA MAFF-QR

M6/antracyt dostępna z trzema wariantami rozet:
BB, PZ i WC



KLAMKA MAFF-QR
BB, M6/antracyt



KLAMKA MAFF-QR
PZ, M6/antracyt



KLAMKA MAFF-QR
WC, M6/antracyt

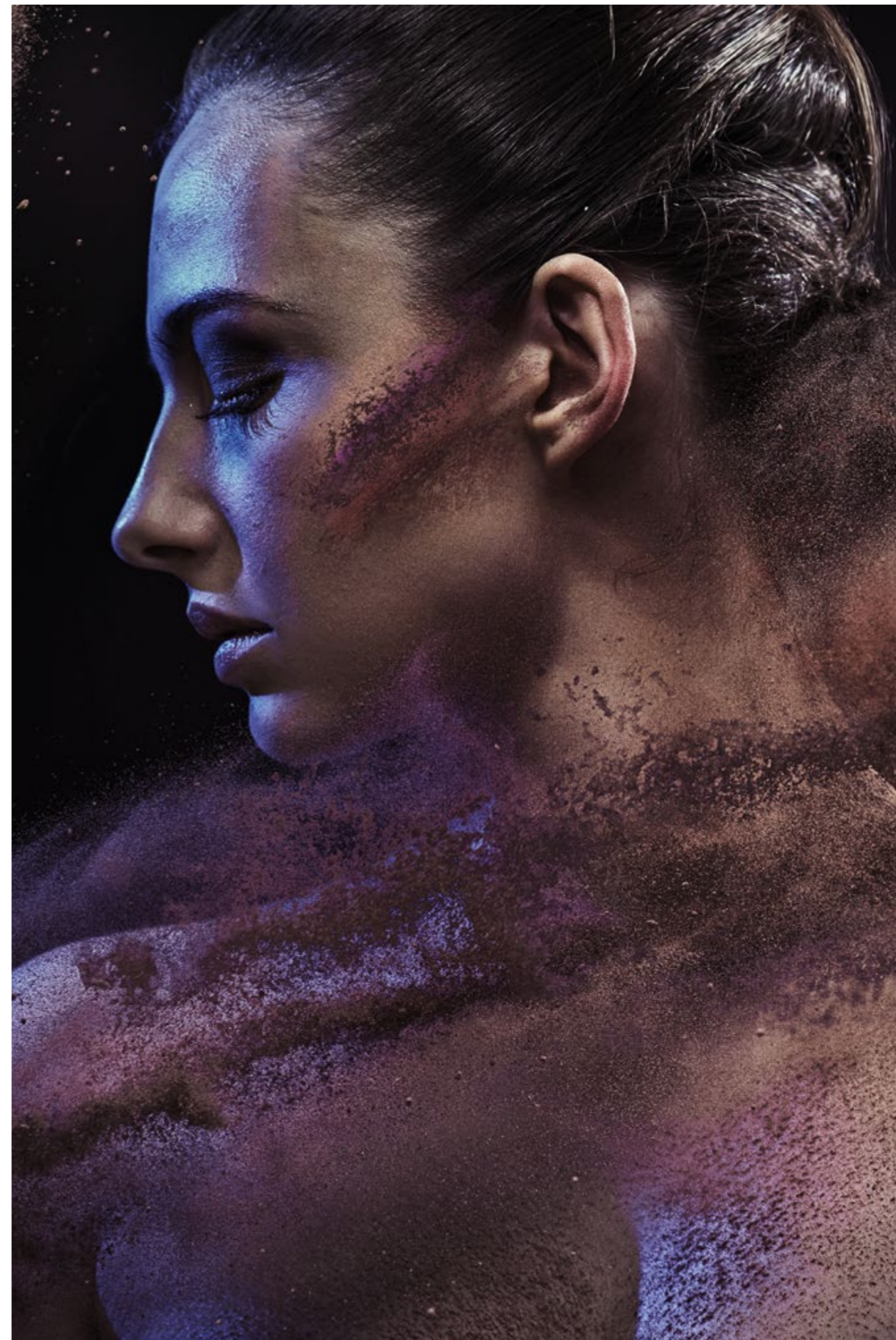



Francuska dusza

Wykonana w kolorze chromu kłamka w stylu retro. Wyposażona w rączkę o wyszukanej, dopasowanej do kształtu dłoni formie. Wyróżnia się dekoracyjnością oraz białym akcentem rączki.

KLAMKA LUDWIK-R

M6/white dostępna z trzema wariantami rozet: BB, PZ i WC



KLAMKA LUDWIK-R
M6/white, BB



KLAMKA LUDWIK-R
M6/white, PZ



KLAMKA LUDWIK-R
M6/white, WC

Jasny akcent



Okrągły szyld i wąska rękojeść o zaokrąglonych brzegach to stylowe połączenie, pasujące do wnętrza o różnym wystroju. Białe akcenty na przodzie rękojeści oraz prosta linia łącząca rączkę z szyldem nadają klamce wyjątkowego charakteru.

KLAMKA ONYKS-R

M6/white dostępna z trzema wariantami rozet: BB, PZ i WC



KLAMKA ONYKS-R
M6/white, BB



KLAMKA ONYKS-R
M6/white, PZ



KLAMKA ONYKS-R
M6/white, WC





Klasa i styl



Standardowy wzór klamki został wzbogacony o delikatne ścięcia na jej rękojeści. Kolor nadaje całości wyszukanego smaku, aby zdobić wnętrza miłośników eleganckiej stylistyki.

KLAMKA JEZZ-QR

M9, dostępna w trzech wariantach:
BB, PZ i WC



KLAMKA JEZZ-QR
M9, BB



KLAMKA JEZZ-QR
M9, PZ



KLAMKA JEZZ-QR
M9, WC

SIŁA

geometrii

Mocny akcent geometrycznych linii rączki dodatkowo podkreśla kolor chromu, a kwadratowy szyld jest dopełnieniem jej wyrazistego charakteru. Ten wzór spodoba się zwolennikom dominujących detali.

KLAMKA PIRA-QR

M6, dostępna w trzech wariantach:
BB, PZ i WC

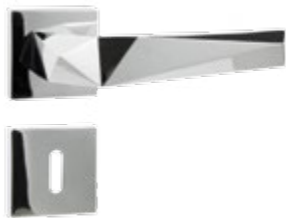

KLAMKA PIRA-QR
M6, BB

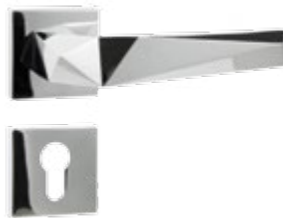

KLAMKA PIRA-QR
M6, PZ

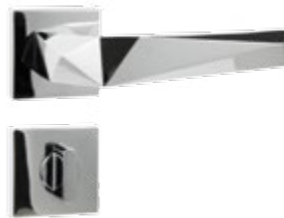

KLAMKA PIRA-QR
M6, WC





Złoty **podział**

Klamka, w której ekspresyjna geometria została zatopiona w niklu, a sztyld w kształcie kwadratu nawiązuje do nowoczesnego wystroju. Taki design pasuje do wnętrz o ciepłych barwach i klasycznym stylu.

KLAMKA QUEZO-QR

M9, dostępna w trzech wariantach:
BB, PZ i WC



KLAMKA QUEZO-QR
M9, BB



KLAMKA QUEZO-QR
M9, PZ



KLAMKA QUEZO-QR
M9, WC

Urok detalu

Okrągły szyld i zaokrąglone linie klamki tworzą harmonijną kompozycję. Przód rękojeści został pokryty delikatnym wzorem wykonanym na białej emalii.

KLAMKA SNAP-R

M6/white dostępna z trzema wariantami rozet: BB, PZ i WC



KLAMKA SNAP-R
M6/white, BB



KLAMKA SNAP-R
M6/white, PZ



KLAMKA SNAP-R
M6/white, WC





Klamki na **dzielonym szyldzie kwadratowym**



Alma-QR



Szyld Alma-QR

	Netto	Brutto
Klamka dzielona	68,41	84,14
Szyld BB PZ	16,99	20,90
Szyld WC	22,97	28,25

Figo-QR

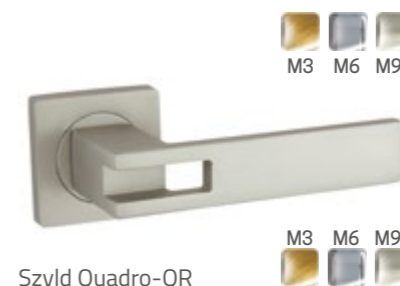

Szyld Quadro-QR

	Netto	Brutto
Klamka dzielona	44,63	54,90
Szyld BB PZ	19,55	24,04
Szyld WC	27,24	33,50

Baltic-QR



Szyld Quadro-QR

	Netto	Brutto
Klamka dzielona	67,53	83,06
Szyld BB PZ	19,55	24,04
Szyld WC	27,24	33,50

Coral-QR



Szyld Quadro-QR

	Netto	Brutto
Klamka dzielona	30,64	37,69
Szyld BB PZ	19,55	24,04
Szyld WC	27,24	33,50

Cube-RT



Szyld RT

	Netto	Brutto
Klamka dzielona	78,94	97,10
Szyld BB PZ	15,28	18,80
Szyld WC	22,97	28,25

Eris-QR



Szyld Quanta-QR

	Netto	Brutto
Klamka dzielona	46,46	57,14
Szyld BB PZ	19,55	24,04
Szyld WC	27,24	33,50

Ene-QR



Szyld KW-QR

	Netto	Brutto
Klamka dzielona	31,52	38,77
Szyld BB PZ	19,55	24,04
Szyld WC	27,24	33,50



Fokus-QR



domino

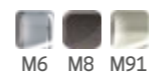

Szyld Quadro-QR

	M6	M8	M91
Klamka dzielona	42,94		52,81
Szyld BB PZ	19,55		24,04
Szyld WC	27,24		33,50

Fero-QR

domino



Szyld Quadro-QR

	M91
Klamka dzielona	29,19 35,90
Szyld BB PZ	19,55 24,04
Szyld WC	27,24 33,50

Fremo-QR

domino



Szyld Quadro-QR

	M9	M91
Klamka dzielona	29,19 35,90	
Szyld BB PZ	19,55 24,04	
Szyld WC	27,24 33,50	

Galaxy-QR

domino



Szyld Quadro-QR

	M6/M9
Klamka dzielona	55,23 67,93
Szyld BB PZ	19,55 24,04
Szyld WC	27,24 33,50

Gustaw-QR

domino



Szyld Quadro-QR

	M3
Klamka dzielona	64,96 79,90
Szyld BB PZ	19,55 24,04
Szyld WC	27,24 33,50

Insignia-QR

domino



Szyld Quadro-QR

	M6/M9
Klamka dzielona	40,11 49,33
Szyld BB PZ	19,55 24,04
Szyld WC	27,24 33,50

Jane-QR

domino



Szyld Quadro-QR

	M3	M9
Klamka dzielona	61,38 75,50	
Szyld BB PZ	19,55 24,04	
Szyld WC	27,24 33,50	

Jaro-QR

domino



Szyld Quadro-QR

	M6/M9
Klamka dzielona	65,24 80,25
Szyld BB PZ	19,55 24,04
Szyld WC	27,24 33,50

Jaro-QR eco



domino



Szyld Quadro-QR

	M6/M9
Klamka dzielona	41,79 51,40
Szyld BB PZ	19,55 24,04
Szyld WC	27,24 33,50



Joon-QR



domino



Szyld Quanta-QR



	Netto	Brutto
Klamka dzielona	42,92	52,80
Szyld BB PZ	19,55	24,04
Szyld WC	27,24	33,50

Kyrk-QR

domino



Szyld Quadro-QR



	Netto	Brutto
Klamka dzielona	64,96	79,90
Szyld BB PZ	19,55	24,04
Szyld WC	27,24	33,50

Line-RT



domino



Szyld RT



	Netto	Brutto
Klamka dzielona	121,08	148,93
Szyld BB PZ	15,28	18,80
Szyld WC	22,97	28,25

Logo-QR

domino

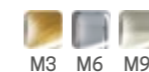

Szyld Quadro-QR



	Netto	Brutto
Klamka dzielona	73,67	90,62
Szyld BB PZ	19,55	24,04
Szyld WC	27,24	33,50

Milano-QR

domino



Szyld Quadro-QR



	Netto	Brutto
Klamka dzielona	95,62	117,62
Szyld BB PZ	19,55	24,04
Szyld WC	27,24	33,50

Modena-QR

domino



Szyld Quadro-QR



	Netto	Brutto
Klamka dzielona	73,67	90,62
Szyld BB PZ	19,55	24,04
Szyld WC	27,24	33,50

Maff-QR



domino



Szyld Quanta-QR



	Netto	Brutto
Klamka dzielona	42,92	52,80
Szyld BB PZ	19,55	24,04
Szyld WC	27,24	33,50



Minimal-RT



domino



Szyld RT



	Netto	Brutto
Klamka dzielona	78,94	97,10
Szyld BB PZ	15,28	18,80
Szyld WC	22,97	28,25

Net-QR

domino



Szyld Quadro-QR



	Netto	Brutto
Klamka dzielona	29,19	35,90
Szyld BB PZ	19,55	24,04
Szyld WC	27,24	33,50

Omega-QR

domino



Szyld Quadro-QR



	Netto	Brutto
Klamka dzielona	46,46	57,14
Szyld BB PZ	19,55	24,04
Szyld WC	27,24	33,50

Palermo-QR

domino



Szyld Quadro-QR



	Netto	Brutto
Klamka dzielona	56,11	69,02
Szyld BB PZ	19,55	24,04
Szyld WC	27,24	33,50

Quanta-QR



domino



Szyld Quanta-QR



	Netto	Brutto
Klamka dzielona	44,31	54,50
Szyld BB PZ	19,55	24,04
Szyld WC	27,24	33,50

Qubik-QR



domino



Szyld Quadro-QR



	Netto	Brutto
Klamka dzielona	45,13	55,51
Szyld BB PZ	19,55	24,04
Szyld WC	27,24	33,50



Presto-QR



Szyld Quadro-QR



	Netto	Brutto
Klamka dzielona	42,63	52,43
Szyld BB PZ	19,55	24,04
Szyld WC	27,24	33,50

Real-QR



Szyld KW-QR



	Netto	Brutto
Klamka dzielona	40,11	49,33
Szyld BB PZ	19,55	24,04
Szyld WC	27,24	33,50

Romana-QR



Szyld Quadro-QR



	Netto	Brutto
Klamka dzielona	50,15	61,69
Szyld BB PZ	19,55	24,04
Szyld WC	27,24	33,50

Sky-QR



Szyld Quadro-QR



	Netto	Brutto
Klamka dzielona	70,15	86,29
Szyld BB PZ	19,55	24,04
Szyld WC	27,24	33,50

Stuu-QR



Szyld Quanta-QR



	Netto	Brutto
Klamka dzielona	42,92	52,80
Szyld BB PZ	19,55	24,04
Szyld WC	27,24	33,50

Time-QR



Szyld Quadro-QR



	Netto	Brutto
Klamka dzielona	71,91	88,45
Szyld BB PZ	19,55	24,04
Szyld WC	27,24	33,50

Tre-QR



Szyld Quadro-QR



	Netto	Brutto
Klamka dzielona	55,23	67,93
Szyld BB PZ	19,55	24,04
Szyld WC	27,24	33,50

Twist-RT



Szyld RT



	Netto	Brutto
Klamka dzielona	78,94	97,10
Szyld BB PZ	15,28	18,80
Szyld WC	22,97	28,25



Klamki na **dzielonym
szyldzie kwadratowym**
PREMIUM





Andy-QR



Szyld Oro-QR

M3 MAT M9

	Netto	Brutto
Klamka dzielona	138,31	170,12
Szyld BB PZ	21,06	25,91
Szyld WC	26,75	32,91

Delux-QR



Szyld Oro-QR

M6 M9

	Netto	Brutto
Klamka dzielona	138,31	170,12
Szyld BB PZ	21,06	25,91
Szyld WC	26,75	32,91

Biblo-QR



	Netto	Brutto
Klamka BB PZ	203,09	249,80
Klamka WC	251,75	309,65

Electra-QR Cristal



Szyld 546-Q

M7/M9

	Netto	Brutto
Klamka dzielona	680,49	837,01
Szyld BB PZ	49,09	60,39
Szyld WC	109,92	135,20



Etar-QR



	Netto	Brutto
Klamka BB PZ	236,38	290,75
Klamka WC	254,32	312,81

Gazela-QR



Szyld Oro-QR



	Netto	Brutto
Klamka dzielona	221,88	272,90
Szyld BB PZ	21,06	25,91
Szyld WC	26,75	32,91

Frame-QR



	Netto	Brutto
Klamka BB PZ	388,05	477,31
Klamka WC	425,61	523,50

Helena-QR



Szyld 546-Q



	Netto	Brutto
Klamka dzielona	293,25	360,70
Szyld BB PZ	49,09	60,39
Szyld WC	109,92	135,20



Jezz-QR



	Netto	Brutto
Klamka BB PZ	236,38	290,75
Klamka WC	254,32	312,81

Liva-QR



	Netto	Brutto
Klamka BB PZ	229,55	282,35
Klamka WC	249,19	306,51

Limone-QR



Szyld Oro-QR



	Netto	Brutto
Klamka dzielona	194,24	238,91
Szyld BB PZ	21,06	25,91
Szyld WC	26,75	32,91

Magnet-QR



Szyld Oro-QR

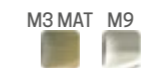

	Netto	Brutto
Klamka dzielona	138,31	170,12
Szyld BB PZ	21,06	25,91
Szyld WC	26,75	32,91



Maya-QR

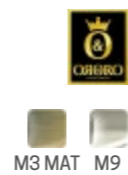
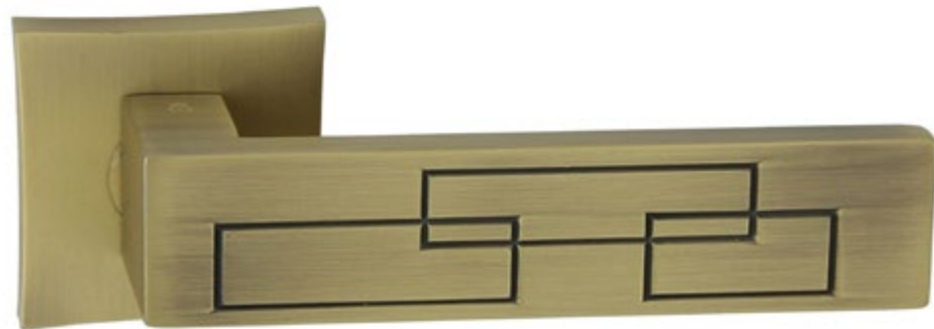

Szyld Oro-QR

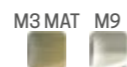

	Netto	Brutto
Klamka dzielona	138,31	170,12
Szyld BB PZ	21,06	25,91
Szyld WC	26,75	32,91

Maya-QR Cristal



Szyld Oro-QR



	Netto	Brutto
Klamka dzielona	246,27	302,91
Szyld BB PZ	21,06	25,91
Szyld WC	26,75	32,91



Miami-QR



	Netto	Brutto
Klamka BB PZ	211,62	260,29
Klamka WC	261,13	321,19

Navy-QR



	Netto	Brutto
Klamka BB PZ	290,16	356,90
Klamka WC	338,69	416,59



Pira-QR

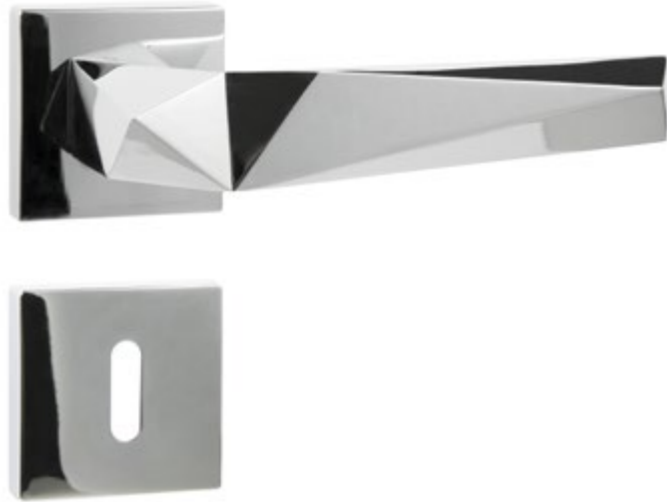

	Netto	Brutto
Klamka BB PZ	213,33	262,40
Klamka WC	232,98	286,56

Rainbow-QR



Szyld Oro-QR



	Netto	Brutto
Klamka dzielona	221,88	272,91
Szyld BB PZ	21,06	25,91
Szyld WC	26,75	32,91

Quezo-QR



	Netto	Brutto
Klamka BB PZ	229,55	282,35
Klamka WC	249,19	306,51

Sedar-QR



	Netto	Brutto
Klamka BB PZ	250,89	308,60
Klamka WC	267,97	329,60



Tiger-QR

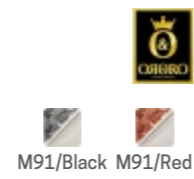

Szyld Oro-QR 

	Netto	Brutto
Klamka dzielona	221,88	272,91
Szyld BB PZ	21,06	25,91
Szyld WC	26,75	32,91

Toro-QR



Szyld Oro-QR 

	Netto	Brutto
Klamka dzielona	138,31	170,12
Szyld BB PZ	21,06	25,91
Szyld WC	26,75	32,91

Tora-QR

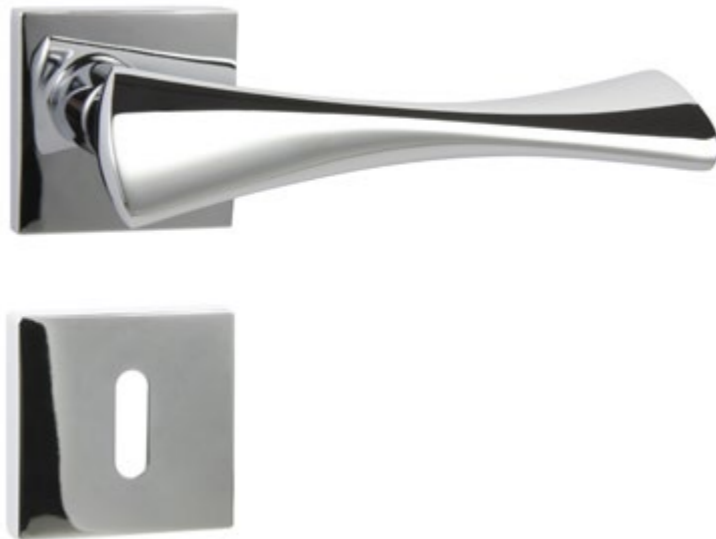

	Netto	Brutto
Klamka BB PZ	203,95	250,85
Klamka WC	223,57	275,00

Vertigo-QR



	Netto	Brutto
Klamka BB PZ	358,46	440,91
Klamka WC	407,12	500,76



Yoda-QR

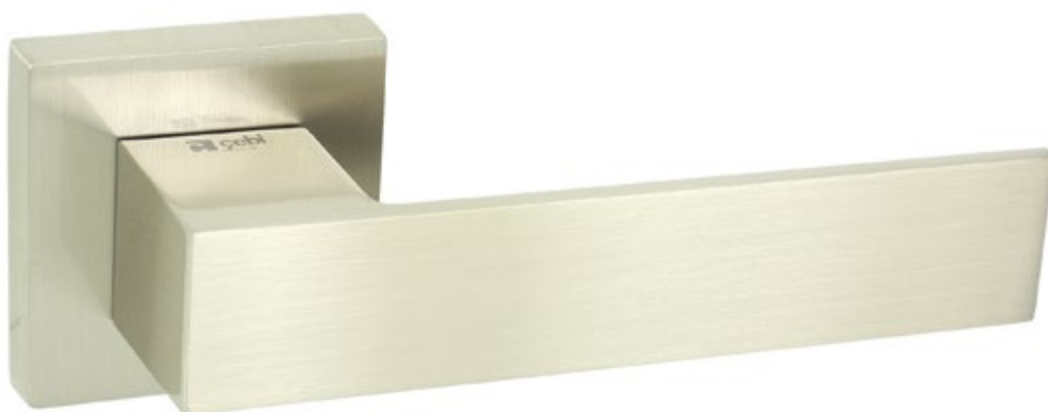

	Netto	Brutto
Klamka BB PZ	229,55	282,35
Klamka WC	249,19	306,51



Klamki na **dzielonym
szyldzie okrągłym**





Afrodyta-R



Szyld 900

	Netto	Brutto
Klamka dzielona	75,42	92,77
Szyld BB PZ	14,43	17,74
Szyld WC	25,52	31,39

Alma-R eco

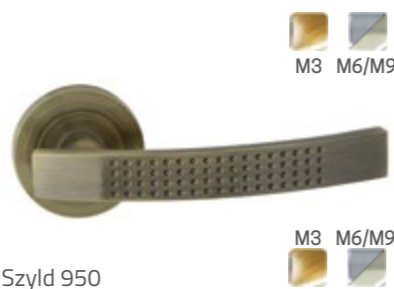

Szyld 950

	Netto	Brutto
Klamka dzielona	31,74	39,04
Szyld BB PZ	13,57	16,69
Szyld WC	25,52	31,39

Ballen-R

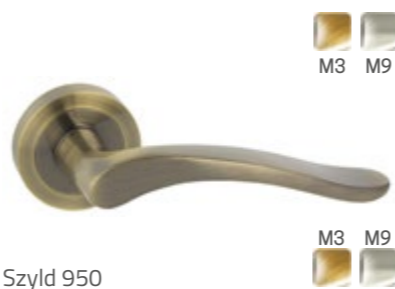

Szyld 950

	Netto	Brutto
Klamka dzielona	31,74	39,04
Szyld BB PZ	13,57	16,69
Szyld WC	25,52	31,39

Dekan-R



Szyld 950

	Netto	Brutto
Klamka dzielona	33,42	41,11
Szyld BB PZ	13,57	16,69
Szyld WC	25,52	31,39

Elizabeth-R



Szyld 950

	Netto	Brutto
Klamka dzielona	49,96	61,46
Szyld BB PZ	13,57	16,69
Szyld WC	25,52	31,39

Bilbao-R

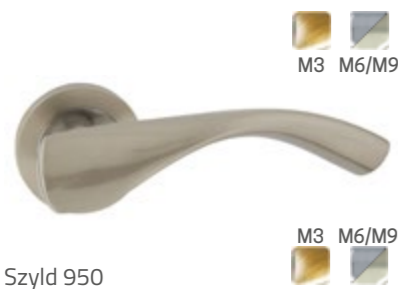

Szyld 950

	Netto	Brutto
Klamka dzielona	32,40	39,85
Szyld BB PZ	13,57	16,69
Szyld WC	25,52	31,39

Biskopt-R



Szyld Biskopt-R

	Netto	Brutto
Klamka dzielona	11,54	14,20
Szyld BB PZ	3,49	4,29
Szyld WC	7,95	9,78

Casablanca-R



Szyld 950

	Netto	Brutto
Klamka dzielona	33,28	40,94
Szyld BB PZ	13,57	16,69
Szyld WC	25,52	31,39

Enigma-R



Szyld 980

	Netto	Brutto
Klamka dzielona	35,04	43,10
Szyld BB PZ	15,28	18,80
Szyld WC	24,67	30,34

Ellegant-R



Szyld 950

	Netto	Brutto
Klamka dzielona	73,85	90,83
Szyld BB PZ	13,57	16,69
Szyld WC	25,52	31,39

Econom-R



Szyld Econom-R

	Netto	Brutto
Klamka dzielona	8,85	10,89
Szyld BB PZ	2,59	3,18
Szyld WC	5,28	6,49

Capri-R



Szyld 980

	Netto	Brutto
Klamka dzielona	33,28	40,94
Szyld BB PZ	15,28	18,80
Szyld WC	24,67	30,34

Fly-R eco

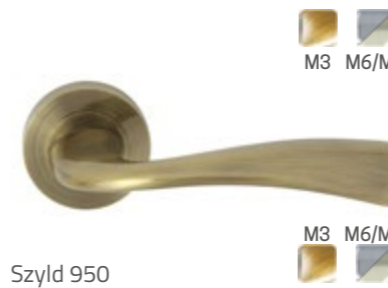

Szyld 950

	Netto	Brutto
Klamka dzielona	32,40	39,85
Szyld BB PZ	13,57	16,69
Szyld WC	25,52	31,39

Fokus-R



Szyld 950

	Netto	Brutto
Klamka dzielona	42,94	52,81
Szyld BB PZ	13,57	16,69
Szyld WC	25,52	31,39

Galaxy-R



Szyld 950

	Netto	Brutto
Klamka dzielona	53,47	65,77
Szyld BB PZ	13,57	16,69
Szyld WC	25,52	31,39



Ibis-R



Szyld 950



	Netto	Brutto
Klamka dzielona	31,50	38,75
Szyld BB PZ	13,57	16,69
Szyld WC	25,52	31,39

Insignia-R



Szyld 950

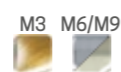

	Netto	Brutto
Klamka dzielona	30,90	38,01
Szyld BB PZ	13,57	16,69
Szyld WC	25,52	31,39

Jane-R



Szyld 950



	Netto	Brutto
Klamka dzielona	36,79	45,25
Szyld BB PZ	13,57	16,69
Szyld WC	25,52	31,39

Ludwik-R



Szyld 950



	Netto	Brutto
Klamka dzielona	73,85	90,83
Szyld BB PZ	13,57	16,69
Szyld WC	25,52	31,39

Jane-R AG1



Szyld Jane-R AG1



	Netto	Brutto
Klamka dzielona	36,79	45,25
Szyld BB PZ	10,16	12,50
Szyld WC	15,28	18,80

Jaro-R



Szyld 950



	Netto	Brutto
Klamka dzielona	51,83	63,76
Szyld BB PZ	13,57	16,69
Szyld WC	25,52	31,39

Jaro-R eco



Szyld 950



	Netto	Brutto
Klamka dzielona	31,74	39,04
Szyld BB PZ	13,57	16,69
Szyld WC	25,52	31,39

Jola-R



Szyld 950



	Netto	Brutto
Klamka dzielona	33,28	40,94
Szyld BB PZ	13,57	16,69
Szyld WC	25,52	31,39

Kyrk-R



Szyld 950



	Netto	Brutto
Klamka dzielona	19,43	23,90
Szyld BB PZ	13,57	16,69
Szyld WC	25,52	31,39

Lavia-R



Szyld 950



	Netto	Brutto
Klamka dzielona	71,63	88,10
Szyld BB PZ	13,57	16,69
Szyld WC	25,52	31,39

Loft-R



Szyld 950



	Netto	Brutto
Klamka dzielona	54,35	66,85
Szyld BB PZ	13,57	16,69
Szyld WC	25,52	31,39

Pro-R



Szyld Pro-R



	Netto	Brutto
Klamka dzielona	16,01	19,69
Szyld BB PZ	6,18	7,60
Szyld WC	9,75	11,99

Marion-R



Szyld 950



	Netto	Brutto
Klamka dzielona	56,11	69,02
Szyld BB PZ	13,57	16,69
Szyld WC	25,52	31,39



Malta-R



M3 MAT



Szyld 950 

	Netto	Brutto
Klamka dzielona	61,38	75,50
Szyld BB PZ	13,57	16,69
Szyld WC	25,52	31,39

Onyks-R



M6/White



Szyld 950 

	Netto	Brutto
Klamka dzielona	73,85	90,83
Szyld BB PZ	13,57	16,69
Szyld WC	25,52	31,39



Modena-R



M3 M9



M3 M9

Szyld 950  

	Netto	Brutto
Klamka dzielona	19,43	23,90
Szyld BB PZ	13,57	16,69
Szyld WC	25,52	31,39



Monaco-R



M3 M9



M3 M9

Szyld 950  

	Netto	Brutto
Klamka dzielona	33,28	40,94
Szyld BB PZ	13,57	16,69
Szyld WC	25,52	31,39



Nova-R



M1 M3 M9



M1 M3 M9

Szyld 950   

	Netto	Brutto
Klamka dzielona	32,40	39,85
Szyld BB PZ	13,57	16,69
Szyld WC	25,52	31,39

Omega-R



M6/M9



M6/M9

Szyld 950 

	Netto	Brutto
Klamka dzielona	46,46	57,14
Szyld BB PZ	13,57	16,69
Szyld WC	25,52	31,39



Oslo-R



M3 M9



M3 M9

Szyld 950  

	Netto	Brutto
Klamka dzielona	33,28	40,94
Szyld BB PZ	13,57	16,69
Szyld WC	25,52	31,39



Otto-R



M3 MAT M6/M9



M3 MAT M6/M9

Szyld 950  

	Netto	Brutto
Klamka dzielona	29,19	35,90
Szyld BB PZ	13,57	16,69
Szyld WC	25,52	31,39



Petra-R



Szyld 950



	Netto	Brutto
Klamka dzielona	32,40	39,85
Szyld BB PZ	13,57	16,69
Szyld WC	25,52	31,39

Presto-R



Szyld 950

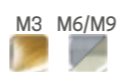

	Netto	Brutto
Klamka dzielona	29,22	35,94
Szyld BB PZ	13,57	16,69
Szyld WC	25,52	31,39

Snap-R



Szyld 980



	Netto	Brutto
Klamka dzielona	73,85	90,83
Szyld BB PZ	15,28	18,80
Szyld WC	24,67	30,34

Rio-R



Szyld 980



	Netto	Brutto
Klamka dzielona	35,04	43,10
Szyld BB PZ	15,28	18,80
Szyld WC	24,67	30,34

Romana-R

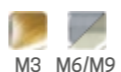

Szyld 950



	Netto	Brutto
Klamka dzielona	32,40	39,85
Szyld BB PZ	13,57	16,69
Szyld WC	25,52	31,39

Tiger-R



Szyld Tiger-R



	Netto	Brutto
Klamka dzielona	9,77	12,02
Szyld BB PZ	3,33	4,09
Szyld WC	6,74	8,29

Sharon-R eco



Szyld 950



	Netto	Brutto
Klamka dzielona	32,40	39,85
Szyld BB PZ	13,57	16,69
Szyld WC	25,52	31,39

Wing-R



Szyld 950



	Netto	Brutto
Klamka dzielona	48,69	59,89
Szyld BB PZ	13,57	16,69
Szyld WC	25,52	31,39

Time-R



Szyld 950



	Netto	Brutto
Klamka dzielona	66,65	81,97
Szyld BB PZ	13,57	16,69
Szyld WC	25,52	31,39



Apollo-R



Szyld 0003/6065



	Netto	Brutto
Klamka dzielona	145,69	179,20
Szyld BB PZ	43,02	52,91
Szyld WC	76,34	93,90

Aquilla-R

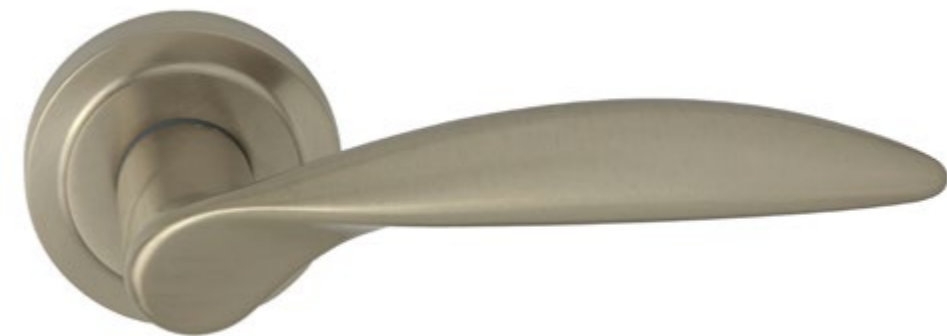

Szyld 555



	Netto	Brutto
Klamka dzielona	182,35	224,29
Szyld BB PZ	47,32	58,20
Szyld WC	102,76	126,39

Klamki na **dzielonym
szyldzie okrągłym**
PREMIUM





Astoria-R



Szyld 555 

	Netto	Brutto
Klamka dzielona	254,80	313,40
Szyld BB PZ	47,32	58,20
Szyld WC	102,76	126,39

Bali-R



Szyld 6060 

	Netto	Brutto
Klamka dzielona	213,66	262,80
Szyld BB PZ	18,68	22,98
Szyld WC	43,73	53,79

Aurea-R



Szyld 6060 

	Netto	Brutto
Klamka dzielona	58,46	71,91
Szyld BB PZ	18,68	22,98
Szyld WC	43,73	53,79

Delphi-R



Szyld 555 

	Netto	Brutto
Klamka dzielona	248,54	305,70
Szyld BB PZ	47,32	58,20
Szyld WC	102,76	126,39

Delux-R



Szyld Oro-R



	Netto	Brutto
Klamka dzielona	122,93	151,20
Szyld BB PZ	21,06	25,91
Szyld WC	26,75	32,91

Frost-R



	Netto	Brutto
Klamka BB PZ	229,55	282,35
Klamka WC	249,19	306,51

Duncan-R



	Netto	Brutto
Klamka BB PZ	229,55	282,35
Klamka WC	249,19	306,51

Gran Pix-R



	Netto	Brutto
Klamka BB PZ	230,65	283,70
Klamka WC	340,65	419,00



Helena-R

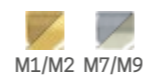

Szyld 555

M1/M2 M7/M9

	Netto	Brutto
Klamka dzielona	299,51	368,40
Szyld BB PZ	47,32	58,20
Szyld WC	102,76	126,39

Ikko-R



Szyld 555

	Netto	Brutto
Klamka BB PZ	229,55	282,35
Klamka WC	249,19	306,51

Hera-R-RS

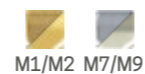

Szyld 555

M1/M2 M7/M9

	Netto	Brutto
Klamka dzielona	268,20	329,89
Szyld BB PZ	47,32	58,20
Szyld WC	102,76	126,39

Iris-R



Szyld 555

M1 M9

	Netto	Brutto
Klamka dzielona	247,64	304,60
Szyld BB PZ	47,32	58,20
Szyld WC	102,76	126,39



Klotho-R



Szyld 555

	Netto	Brutto
Klamka dzielona	225,29	277,10
Szyld BB PZ	47,32	58,20
Szyld WC	102,76	126,39

Lamia-R



Szyld 555

	Netto	Brutto
Klamka dzielona	177,15	217,90
Szyld BB PZ	47,32	58,20
Szyld WC	102,76	126,39

Lady-R Cristal



Szyld Oro-R

	Netto	Brutto
Klamka dzielona	221,54	272,50
Szyld BB PZ	21,06	25,91
Szyld WC	26,75	32,91

Lavinia-R

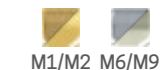

Szyld 555

	Netto	Brutto
Klamka dzielona	234,22	288,09
Szyld BB PZ	47,32	58,20
Szyld WC	102,76	126,39



Lavinia-R Cristal



Szyld 555



	Netto	Brutto
Klamka dzielona	828,96	1019,62
Szyld BB PZ	47,32	58,20
Szyld WC	102,76	126,39

Liva-R

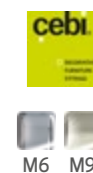

	Netto	Brutto
Klamka BB PZ	229,55	282,35
Klamka WC	249,19	306,51

Leonardo-R



	Netto	Brutto
Klamka BB PZ	346,91	426,70
Klamka WC	386,26	475,10

Matteo-R



	Netto	Brutto
Klamka dzielona	126,91	156,10
Szyld BB PZ	47,32	58,20
Szyld WC	102,76	126,39



Morfeo-R



	Netto	Brutto
Klamka BB PZ	331,70	407,99
Klamka WC	408,62	502,60

Pira-R

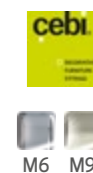

	Netto	Brutto
Klamka BB PZ	213,33	262,40
Klamka WC	232,98	286,56

Pallas-R



Szyld 555

	Netto	Brutto
Klamka dzielona	241,38	296,90
Szyld BB PZ	47,32	58,20
Szyld WC	102,76	126,39

Roma-R



Szyld 555

	Netto	Brutto
Klamka dzielona	197,56	243,00
Szyld BB PZ	47,32	58,20
Szyld WC	102,76	126,39



Polaris-R



M6/Black M6/Red M6/White



	Netto	Brutto
Klamka BB PZ	229,55	282,35
Klamka WC	249,19	306,51

Skin-R



M3 MAT M9



Szyld Oro-R

M3 MAT M9

	Netto	Brutto
Klamka dzielona	138,31	170,12
Szyld BB PZ	21,06	25,91
Szyld WC	26,75	32,91

Snake-R

*klamka tylko do zamków DIN Dormas 55m



M6



Szyld Oro-R

M6

	Netto	Brutto
Klamka dzielona	154,39	189,90
Szyld BB PZ	21,06	25,91
Szyld WC	26,75	32,91



Tora-R



	Netto	Brutto
Klamka BB PZ	203,95	250,85
Klamka WC	223,57	275,00

Tuluza-R



Szyld 6060 

	Netto	Brutto
Klamka dzielona	72,35	88,99
Szyld BB PZ	18,68	22,98
Szyld WC	43,73	53,79

Toro-R

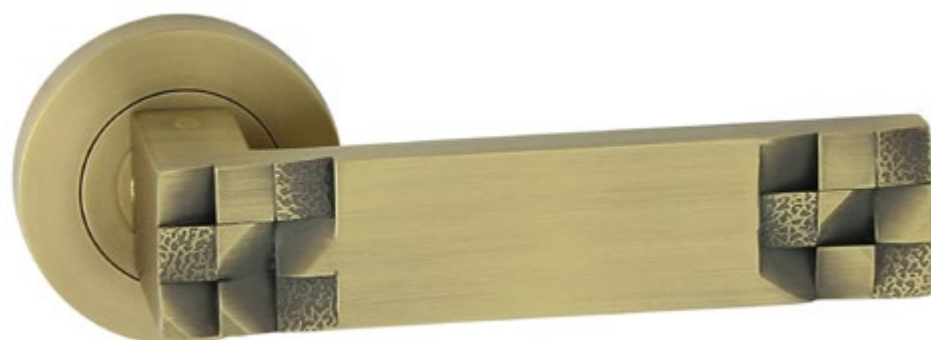

Szyld Oro-R 

	Netto	Brutto
Klamka dzielona	138,31	170,12
Szyld BB PZ	21,06	25,91
Szyld WC	26,75	32,91

Valentina-R



Szyld 6060 

	Netto	Brutto
Klamka dzielona	113,49	139,59
Szyld BB PZ	18,68	22,98
Szyld WC	43,73	53,79



Venus-R



Szyld 6060

	Netto	Brutto
Klamka dzielona	65,19	80,18
Szyld BB PZ	18,68	22,98
Szyld WC	43,73	53,79

Zita-R



Szyld 555

	Netto	Brutto
Klamka dzielona	238,69	293,59
Szyld BB PZ	47,32	58,20
Szyld WC	102,76	126,39



Klamki
na **długim szyldzie**





Afrodyta

domino



M3

	Netto	Brutto
Klamka BB B/O PZ	77,18	94,93
Klamka WC	87,71	107,89

Alma eco

domino



M3 M9

	Netto	Brutto
Klamka BB B/O PZ	34,24	42,12
Klamka WC lewa prawa	37,60	46,25

Atena

domino



M3

	Netto	Brutto
Klamka BB B/O PZ	71,46	87,90
Klamka WC lewa prawa	80,40	98,89

Dekan



domino



M3 M6/M9

	Netto	Brutto
Klamka BB B/O PZ	33,42	41,11
Klamka WC	36,76	45,22

Ballen

domino



M3 M9

	Netto	Brutto
Klamka BB B/O PZ	30,06	36,97
Klamka WC	35,08	43,15

Bilbao

domino



M3 M9

	Netto	Brutto
Klamka BB B/O PZ	39,43	48,50
Klamka WC	46,46	57,14

Biszkopt

domino



biały brąz

	Netto	Brutto
Klamka BB PZ	17,80	21,90
Klamka WC	23,17	28,50

Capri

domino



M3 M6/M9

	Netto	Brutto
Klamka BB B/O PZ	33,28	40,94
Klamka WC	36,79	45,25

Casablanca

domino



M3 M9

	Netto	Brutto
Klamka BB B/O PZ	37,60	46,25
Klamka WC lewa prawa	45,97	56,54

Econom

domino



biały brąz

	Netto	Brutto
Klamka BB B/O PZ	13,32	16,38
Klamka WC	15,11	18,59

Enigma

domino



M3 M6/M9

	Netto	Brutto
Klamka BB B/O PZ	35,04	43,10
Klamka WC	38,55	47,41

Fero

domino



M91

	Netto	Brutto
Klamka BB B/O PZ	32,45	39,91
Klamka WC	37,32	45,91

Figo

domino



M6/M9

	Netto	Brutto
Klamka BB B/O PZ	34,88	42,90
Klamka WC	39,75	48,90



Elizabeth



	Netto	Brutto
Klamka BB B/O PZ	39,43	48,50
Klamka WC lewa prawa	48,20	59,29

Fly eco



	Netto	Brutto
Klamka BB B/O PZ	32,40	39,85
Klamka WC lewa prawa	37,67	46,33

Fokus



	Netto	Brutto
Klamka BB B/O PZ	37,67	46,33
Klamka WC	42,94	52,81

Ibis



	Netto	Brutto
Klamka BB B/O PZ	37,67	46,33
Klamka WC	48,20	59,29

Insignia



	Netto	Brutto
Klamka BB B/O PZ	35,92	44,19
Klamka WC	45,13	55,51

Jaro eco



	Netto	Brutto
Klamka BB B/O PZ	35,08	43,15
Klamka WC	40,11	49,33

Loft



	Netto	Brutto
Klamka BB B/O PZ	66,65	81,97
Klamka WC	70,15	86,29

Jane



	Netto	Brutto
Klamka BB B/O	61,38	75,50
Klamka WC lewa prawa	67,53	83,06

Jola



	Netto	Brutto
Klamka BB B/O* PZ	31,52	38,77
Klamka WC	36,79	45,25

*dotyczy tylko koloru M9

Malta



	Netto	Brutto
Klamka BB B/O PZ	71,03	87,37
Klamka WC lewa prawa	79,82	98,18

Jaro



	Netto	Brutto
Klamka BB B/O PZ	65,24	80,25
Klamka WC lewa prawa	79,47	97,75

Kyrk



	Netto	Brutto
Klamka BB B/O PZ	19,43	23,90
Klamka WC lewa prawa	22,68	27,89

Monaco



	Netto	Brutto
Klamka BB B/O PZ	39,43	48,50
Klamka WC	48,20	59,29

Nova

domino



	Netto	Brutto
Klamka BB B/O PZ	30,64	37,69
Klamka WC	38,55	47,41

Omega

domino



	Netto	Brutto
Klamka BB B/O PZ	35,91	44,17
Klamka WC	42,05	51,73

Oslo

domino



	Netto	Brutto
Klamka BB B/O PZ	39,43	48,50
Klamka WC lewa prawa	48,20	59,29

Romana

domino



	Netto	Brutto
Klamka BB B/O PZ	39,19	48,20
Klamka WC	46,01	56,59

Sharon eco

domino



	Netto	Brutto
Klamka BB B/O PZ	40,31	49,58
Klamka WC	47,32	58,21

Otto

domino



	Netto	Brutto
Klamka BB B/O PZ	34,06	41,90
Klamka WC lewa prawa	40,57	49,90

Petra

domino



	Netto	Brutto
Klamka BB B/O PZ	40,31	49,58
Klamka WC	47,32	58,21

Presto

domino



	Netto	Brutto
Klamka BB B/O PZ	30,90	38,01
Klamka WC lewa prawa	34,24	42,12

Pro

domino



	Netto	Brutto
Klamka BB B/O PZ	20,48	25,19
Klamka WC	24,95	30,68

Real

domino



	Netto	Brutto
Klamka BB B/O PZ	38,44	47,29
Klamka WC	45,13	55,51

Rio

domino



	Netto	Brutto
Klamka BB B/O PZ	35,04	43,10
Klamka WC	38,55	47,41

Tiger

domino



	Netto	Brutto
Klamka BB B/O PZ	15,11	18,59
Klamka WC	18,68	22,98

Tre

domino



	Netto	Brutto
Klamka BB B/O PZ	42,94	52,81
Klamka WC	54,35	66,85

Wing

domino



	Netto	Brutto
Klamka BB B/O PZ	51,96	63,90
Klamka WC lewa prawa	60,08	73,90



Klamki
na **długim szyldzie**
PREMIUM



Apollo



	Netto	Brutto
Klamka BB B/O PZ	145,69	179,20
Klamka WC	178,78	219,90

Atene



	Netto	Brutto
Klamka BB PZ	420,24	516,90
Klamka WC	482,84	593,90

Bali



	Netto	Brutto
Klamka BB B/O PZ	231,55	284,80
Klamka WC	269,10	330,99

Infinita



	Netto	Brutto
Klamka BB PZ	813,75	1000,91
Klamka WC	904,96	1113,11



Tuluza



	Netto	Brutto
Klamka BB B/O PZ	92,93	114,30
Klamka WC	117,96	145,09

Valentina



	Netto	Brutto
Klamka BB B/O PZ	128,69	158,28
Klamka WC	166,26	204,49

Venus



	Netto	Brutto
Klamka BB B/O PZ	89,34	109,89
Klamka WC	112,59	138,49



Klamki ze **stali**
nierdzewnej





Agnessa-QR



Szyld EF SN04-QR

	Netto	Brutto
Klamka dzielona	47,72	58,70
Szyld BB PZ	17,83	21,94
Szyld WC	26,38	32,45

Grisza-QR



Szyld EF SN04-QR

	Netto	Brutto
Klamka dzielona	47,72	58,70
Szyld BB PZ	17,83	21,94
Szyld WC	26,38	32,45

Jane-QR



Szyld EF SN04-QR

	Netto	Brutto
Klamka dzielona	48,01	59,05
Szyld BB PZ	17,83	21,94
Szyld WC	26,38	32,45

Liu-R



Szyld EF Lui-R

	Netto	Brutto
Klamka dzielona	34,07	41,91
Szyld BB PZ	12,71	15,64
Szyld WC	26,38	32,45

Luka-QR



Szyld EF SN04-QR

	Netto	Brutto
Klamka dzielona	47,72	58,70
Szyld BB PZ	17,83	21,94
Szyld WC	26,38	32,45

Padwa-R



Szyld EF Lui-R

	Netto	Brutto
Klamka dzielona	52,84	64,99
Szyld BB PZ	12,71	15,64
Szyld WC	26,38	32,45

Romana-QR



Szyld EF SN04-QR

	Netto	Brutto
Klamka dzielona	64,79	79,70
Szyld BB PZ	17,83	21,94
Szyld WC	26,38	32,45

Romana-R



Szyld EF Lui-R

	Netto	Brutto
Klamka dzielona	57,11	70,24
Szyld BB PZ	12,71	15,64
Szyld WC	26,38	32,45

Prado-R



Szyld EF Lui-R

	Netto	Brutto
Klamka dzielona	34,07	41,91
Szyld BB PZ	12,71	15,64
Szyld WC	26,38	32,45

Siena-R



Szyld EF Lui-R

	Netto	Brutto
Klamka dzielona	52,84	64,99
Szyld BB PZ	12,71	15,64
Szyld WC	26,38	32,45



Sigma-QR



Szyld EF SNO4-QR

	Netto	Brutto
Klamka dzielona	46,01	56,59
Szyld BB PZ	17,83	21,94
Szyld WC	26,38	32,45

Sigma-R



Szyld EF Lui-R

	Netto	Brutto
Klamka dzielona	34,07	41,91
Szyld BB PZ	12,71	15,64
Szyld WC	26,38	32,45

Sigma-R Owal



Szyld EF Owal

	Netto	Brutto
Klamka dzielona	34,07	41,91
Szyld PZ	21,26	26,15

Uno



	Netto	Brutto
Klamka BB B/O PZ	61,39	75,50
Klamka WC	78,46	96,51

Uno 170



	Netto	Brutto
Klamka PZ	57,96	71,29

Uno-R



Szyld EF Lui-R

	Netto	Brutto
Klamka dzielona	34,07	41,91
Klamka dzielona plus	40,03	49,24
Szyld BB PZ	12,71	15,64
Szyld WC	26,38	32,45

Uno 170 Gałka



	Netto	Brutto
Gałka PZ stała	61,39	75,50

Uno Gałka



	Netto	Brutto
Gałka PZ stała	61,39	75,50

Uno-R Owal



Szyld EF Owal

	Netto	Brutto
Klamka dzielona	34,07	41,91
Szyld PZ	21,26	26,15



Klamki na **dzielonym**
szyldzie slim





Jane-QR

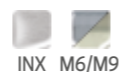

Szyld Slim-QR



		Netto	Brutto
Klamka dzielona	INX	84,21	103,58
	M6/M9	100,89	124,10
Szyld BB PZ	INX	34,07	41,91
	M6	54,55	67,10
Szyld WC	INX	42,94	52,81
	M6	59,09	72,68

Padwa-R



Szyld Slim-R



	Netto	Brutto
Klamka dzielona	86,83	106,81
Szyld BB PZ	30,64	37,69
Szyld WC	38,82	47,75

Jane-R

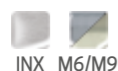

Szyld Slim-R



		Netto	Brutto
Klamka dzielona	INX	77,18	94,93
	M6/M9	84,21	103,58
Szyld BB PZ	INX	30,64	37,69
	M6	44,31	54,50
Szyld WC	INX	38,82	47,75
	M6	55,20	67,89

Insignia-R



Szyld Slim-R



	Netto	Brutto
Klamka dzielona	71,91	88,45
Szyld BB PZ	44,31	54,50
Szyld WC	55,20	67,89

Insignia-QR



Szyld Slim-QR



	Netto	Brutto
Klamka dzielona	81,57	100,33
Szyld BB PZ	54,55	67,10
Szyld WC	59,09	72,68

Siena-R



Szyld Slim-R



	Netto	Brutto
Klamka dzielona	86,83	106,81
Szyld BB PZ	30,64	37,69
Szyld WC	38,82	47,75



Jaro-QR eco



Szyld Slim-QR

	Netto	Brutto
Klamka dzielona	71,03	87,37
Szyld BB PZ	54,55	67,10
Szyld WC	59,09	72,68

Jaro-R eco



Szyld Slim-R

	Netto	Brutto
Klamka dzielona	66,65	81,97
Szyld BB PZ	44,31	54,50
Szyld WC	55,20	67,89

Liu-R



Szyld Slim-R

	Netto	Brutto
Klamka dzielona	69,29	85,22
Szyld BB PZ	30,64	37,69
Szyld WC	38,82	47,75

Prado-R



Szyld Slim-R

	Netto	Brutto
Klamka dzielona	70,15	86,29
Szyld BB PZ	30,64	37,69
Szyld WC	38,82	47,75

Presto-QR



Szyld Slim-QR

	Netto	Brutto
Klamka dzielona	105,28	129,49
Szyld BB PZ	54,55	67,10
Szyld WC	59,09	72,68

Presto-R



Szyld Slim-R

	Netto	Brutto
Klamka dzielona	68,41	84,14
Szyld BB PZ	44,31	54,50
Szyld WC	55,20	67,89

Sigma-QR



Szyld Slim-QR

	Netto	Brutto
Klamka dzielona	82,45	101,41
Szyld BB PZ	34,07	41,91
Szyld WC	42,94	52,81

Sigma-R



Szyld Slim-R

	Netto	Brutto
Klamka dzielona	70,15	86,29
Szyld BB PZ	30,64	37,69
Szyld WC	38,82	47,75

Uno-R



Szyld Slim-R

	Netto	Brutto
Klamka dzielona	70,15	86,29
Szyld BB PZ	30,64	37,69
Szyld WC	38,82	47,75



Szyldy



0006 Plus



10710

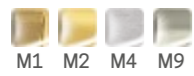

Szyld PZ	Netto	Brutto
	13,57	16,69



Szyld PZ	Netto	Brutto
	27,55	33,89

900



BB



PZ



WC



980



BB



PZ



WC



Szyld BB PZ	Netto	Brutto
	14,43	17,74
Szyld WC	Netto	Brutto
	25,52	31,39



Szyld BB PZ	Netto	Brutto
	15,28	18,80
Szyld WC	Netto	Brutto
	24,67	30,34

EF Owal



Owalny Plus



Szyld PZ	Netto	Brutto
	21,26	26,15

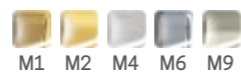

Szyld PZ	Netto	Brutto
	15,28	18,80

Biskopt-R



BB



PZ



WC



Econom-R



BB



PZ



WC

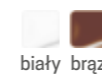

Szyld BB PZ	Netto	Brutto
	3,49	4,29
Szyld WC	Netto	Brutto
	7,95	9,78

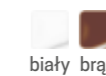

Szyld BB PZ	Netto	Brutto
	2,59	3,18
Szyld WC	Netto	Brutto
	5,28	6,49

950



BB



PZ



WC



Szyld BB PZ	Netto	Brutto
	13,57	16,69
Szyld WC	Netto	Brutto
	25,52	31,39

Alma-QR



BB



PZ



WC



Szyld BB PZ	Netto	Brutto
	16,99	20,90
Szyld WC	Netto	Brutto
	22,97	28,25

EF 200



Szyld WC	Netto	Brutto
	26,38	32,45



EF Lui-R



	Netto	Brutto
Szyld BB PZ	12,71	15,64
Szyld WC	26,38	32,45

EF SNO4-QR



	Netto	Brutto
Szyld BB PZ	17,83	21,94
Szyld WC	26,38	32,45

Pro-R



	Netto	Brutto
Szyld BB PZ	6,18	7,60
Szyld WC	9,75	11,99

Quanta-QR



	Netto	Brutto
Szyld BB PZ	19,55	22,90
Szyld WC	27,24	31,91

Jane-R AG1



	Netto	Brutto
Szyld BB PZ	10,16	12,50
Szyld WC	15,28	18,80

KW-QR



	Netto	Brutto
Szyld BB PZ	19,55	24,04
Szyld WC	27,24	33,50

Slim-QR



	Netto	Brutto
Szyld BB PZ	INX 34,07	41,91
Szyld WC	M6 54,55	67,10
Szyld WC	INX 42,94	52,81
Szyld WC	M6 59,09	72,68

Slim-R



	Netto	Brutto
Szyld BB PZ	INX 30,64	37,69
Szyld WC	M6 44,31	54,50
Szyld WC	INX 38,82	47,75
Szyld WC	M6 55,20	67,89

Quadro-QR



	Netto	Brutto
Szyld BB PZ	19,55	24,04
Szyld WC	27,24	33,50

Quadro-QR M6/M9



	Netto	Brutto
Szyld BB PZ	19,55	24,04
Szyld WC	27,24	33,50

RT



	Netto	Brutto
Szyld BB PZ	15,28	18,80
Szyld WC	22,97	28,25

Tiger-R



	Netto	Brutto
Szyld BB PZ	3,33	4,09
Szyld WC	6,74	8,29

0003/6065



BB

PZ

WC

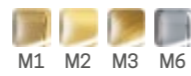

	Netto	Brutto
Szyld BB PZ	43,02	52,91
Szyld WC	76,34	93,90

6060



BB

PZ

WC



	Netto	Brutto
Szyld BB PZ	18,68	22,98
Szyld WC	43,73	53,79

546-Q



BB

PZ

WC

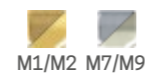

	Netto	Brutto
Szyld BB PZ	49,09	60,39
Szyld WC	109,92	135,20

Oro-QR



BB

PZ

WC



	Netto	Brutto
Szyld BB PZ	21,06	25,91
Szyld WC	26,75	32,91

555



BB

PZ

WC



	Netto	Brutto
Szyld BB PZ	47,32	58,20
Szyld WC	102,76	126,39

Oro-R



BB

PZ

WC



	Netto	Brutto
Szyld BB PZ	21,06	25,91
Szyld WC	26,75	32,91



Gałki



2055-R



Szyld EF Lui-R

	Netto	Brutto
Gałka ruchoma (szt.)	42,94	52,81
Gałka stała (szt.)	42,94	52,81
Szyld BB PZ	12,71	15,64
Szyld WC	26,38	32,45

2065-QR



Szyld Quadro-QR

	Netto	Brutto
Gałka ruchoma (szt.)	45,58	56,06
Gałka stała (szt.)	45,58	56,06
Szyld BB PZ	19,55	24,04
Szyld WC	27,24	33,50

2075-R



Szyld 950

	Netto	Brutto
Gałka ruchoma (szt.)	45,58	56,06
Gałka stała (szt.)	45,58	56,06
Szyld BB PZ	13,57	16,69
Szyld WC	25,52	31,39

AT-R eco



Szyld 950

	Netto	Brutto
Gałka ruchoma (kpl.)	49,51	60,90
Gałka stała (szt.)	27,13	33,37
Szyld BB PZ	13,57	16,69
Szyld WC	25,52	31,39

6711 Prosta



Gałka z zamkiem

	Netto	Brutto
Gałka	35,04	43,10

6871 Kula



Gałka z zamkiem

	Netto	Brutto
Gałka	35,04	43,10

Linoza-R



	Netto	Brutto
Gałka	143,90	177,00
Szyld BB PZ	47,32	58,20
Szyld WC	102,76	126,39

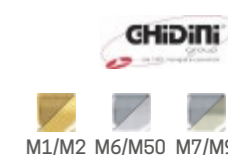

Szyld 555

Apollo-R + gałka



	Netto	Brutto
Gałka lewa prawa	130,00	159,90
Szyld BB PZ	43,02	52,91
Szyld WC	76,34	93,90

Szyld 0003/6065

Skin-R



	Netto	Brutto
Gałka	185,28	227,90
Szyld BB PZ	21,06	25,91
Szyld WC	26,75	32,91

Szyld Oro-R



Klamki do **drzwi zewnętrznych**



Alma zew. K+K



Szyld Jane zew.



	Netto	Brutto
Klamka PZ lewa prawa	73,67	90,62
Szyld krótki PZ	30,64	37,69

Galaxy zew. K+K



Szyld 800 zew.



	Netto	Brutto
Klamka dzielona lewa prawa	49,96	61,46
Szyld PZ	14,43	17,74

Fokus zew. K+K

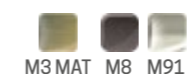

Szyld Fokus zew.



	Netto	Brutto
Klamka PZ	82,45	101,41
Szyld krótki PZ	28,93	35,59

Fokus zew. K+P



Szyld Fokus zew.

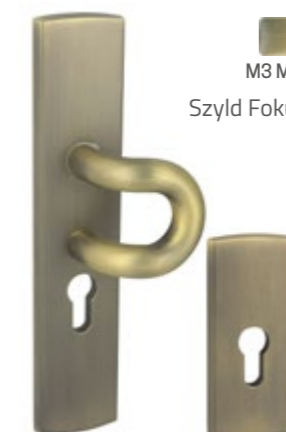

	Netto	Brutto
Klamka PZ lewa prawa	87,71	107,89
Szyld krótki PZ	28,93	35,59

Haga K+K



Szyld Niagara



	Netto	Brutto
Klamka PZ kl. I	88,68	109,07
Szyld długi PZ kl. I	39,27	48,30
Szyld krótki PZ kl. I	36,76	45,22



Jane zew. K+K



Szyld Jane zew.



Manitoba Plus K+K AXA



Szyld Manitoba



	Netto	Brutto
Klamka PZ kl. I	96,22	118,35
Szyld krótki kl. I	36,76	45,22

Romana zew. K+K



Szyld Jane zew.



Ottawa K+K AXA



Szyld Ottawa



	Netto	Brutto
Klamka PZ	69,42	85,39
Szyld krótki PZ	26,72	32,86

	Netto	Brutto
Klamka PZ lewa prawa	73,32	90,19
Szyld krótki PZ	30,64	37,69

	Netto	Brutto
Klamka PZ lewa prawa	73,67	90,62
Szyld krótki PZ	30,64	37,69

Lana K+K



Szyld Diec 7037



	Netto	Brutto
Klamka PZ	143,34	176,30
Szyld krótki	87,85	108,05

Lana K+P



Szyld Diec 7037



	Netto	Brutto
Klamka PZ	164,68	202,55
Szyld krótki	87,85	108,05

Omega zew. K+K domino

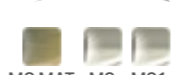

Szyld 800 zew.



	Netto	Brutto
Klamka dzielona lewa prawa	49,96	61,46
Szyld PZ	14,43	17,74

Niagara K+K AXA



Szyld Niagara



	Netto	Brutto
Klamka PZ kl. I	84,49	103,93
Szyld długi PZ kl. I	39,27	48,30
Szyld krótki PZ kl. I	36,76	45,22

Niagara K+P AXA



Szyld Niagara



	Netto	Brutto
Klamka PZ kl. I	96,22	118,35
Szyld długi PZ kl. I	39,27	48,30
Szyld krótki PZ kl. I	36,76	45,22



Prestige K+K



AXA



Szyld Prestige



	Netto	Brutto
Klamka PZ kl. III	179,97	221,36
Szyld długi PZ kl. III	95,38	117,32
Szyld krótki PZ kl. III	95,38	117,32

Prestige K+K z zabezpieczeniem



AXA



Szyld Prestige z zabezpieczeniem

	Netto	Brutto
Klamka PZ kl. III	205,09	252,26
Szyld długi PZ kl. III	120,50	148,21
Szyld krótki PZ kl. III	120,50	148,21

Space zew. K+K z zabezpieczeniem



domino



Szyld Space zew. z zabezpieczeniem

	Netto	Brutto
Klamka PZ lewa prawa	83,33	102,49
Szyld krótki PZ	41,74	51,34

Space zew. K+K



domino



Szyld Space zew.

	Netto	Brutto
Klamka PZ lewa prawa	71,91	88,45
Szyld długi PZ	25,52	31,39
Szyld krótki PZ	25,52	31,39

Prestige K+G

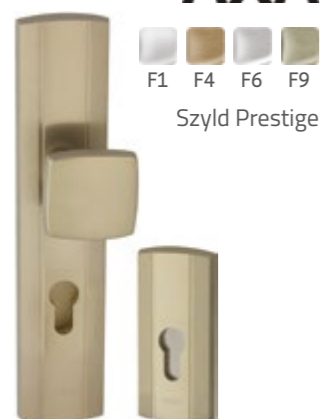

AXA

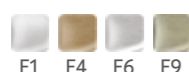

Szyld Prestige

	Netto	Brutto
Klamka PZ kl. III	191,68	235,77
Szyld długi PZ kl. III	95,38	117,32
Szyld krótki PZ kl. III	95,38	117,32

Prestige K+G z zabezpieczeniem



AXA

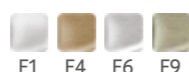

Szyld Prestige z zabezpieczeniem

	Netto	Brutto
Klamka PZ kl. III	218,48	268,73
Szyld długi PZ kl. III	120,50	148,21
Szyld krótki PZ kl. III	120,50	148,21

Space zew. K+P



domino



Szyld Space

	Netto	Brutto
Klamka PZ lewa prawa	83,33	102,49
Szyld długi PZ	25,52	31,39
Szyld krótki PZ	25,52	31,39

Royal K+K



AXA



Szyld Royal

	Netto	Brutto
Klamka PZ kl. III	179,97	221,36
Szyld krótki kl. III	95,38	117,32

Royal K+K z zabezpieczeniem



AXA



Szyld Royal z zabezpieczeniem

	Netto	Brutto
Klamka PZ kl. III	205,09	252,26
Szyld krótki kl. III	120,50	148,21



Rondo K+K



Szyld Diec 7030



Netto Brutto

Klamka PZ	145,89	179,44
Szyld krótki	109,19	134,30

Rondo K+G



Szyld Diec 7030



Netto Brutto

Klamka PZ	133,93	164,74
Szyld krótki	109,19	134,30

Klamki bramowe

Ares



czarny



Netto Brutto

Klamka PZ	42,05	51,73
-----------	--------------	-------

Hades P18



czarny



Netto Brutto

Klamka PZ	33,28	40,94
-----------	--------------	-------

Dostępne rozstawy klamek do drzwi zewnętrznych

	rozstaw	F1	F2	F3	F4	F9	F6	M3	M3/Mat	M8	M9	M6/M9	M91
Alma zew. K+K	72							D					
Fokus zew. K+K	72								D	D			D
Fokus zew. K+P	72								D				D
Galaxy zew. K+K									D				D
Haga K+K	72	D			D	D	D						
Haga K+K	90	n/z			n/z	n/z	n/z						
Haga K+K	92	n/z			n/z	n/z	n/z						
Jane zew. K+K	72							D				D	
Jane zew. K+K	90							D				D	
Jane zew. K+K	92							D				D	
Lana K+K	72	D			D								
Lana K+P	72	D			D								
Manitoba K+K	72	n/z			n/z	n/z	n/z						
Niagara K+K	72	D			D	D	D						
Niagara K+K	90	n/z			n/z	n/z	n/z						
Niagara K+K	92	n/z			n/z	n/z	n/z						
Niagara K+P	72	n/z			n/z	n/z	n/z						
Niagara K+P	90	n/z			n/z	n/z	n/z						
Niagara K+P	92	n/z			n/z	n/z	n/z						
Omega zew. K+K									D		D		D
Ottawa K+K	72	D			D	D	D						
Prestige K+G kl. III	72	n/z			n/z	n/z	n/z						
Prestige K+G kl. III	90	n/z			n/z	n/z	n/z						
Prestige K+G kl. III	92	n/z			n/z	n/z	n/z						
Prestige K+G kl. III z zab.	72	n/z			n/z	n/z	n/z						
Prestige K+G kl. III z zab.	90	n/z			n/z	n/z	n/z						
Prestige K+G kl. III z zab.	92	n/z			n/z	n/z	n/z						
Prestige K+K kl. III	72	D			D	D	D						
Prestige K+K kl. III	90	n/z			n/z	n/z	n/z						
Prestige K+K kl. III	92	n/z			n/z	n/z	n/z						
Prestige K+K kl. III z zab.	72	n/z			n/z	n/z	n/z						
Prestige K+K kl. III z zab.	90	n/z			n/z	n/z	n/z						
Prestige K+K kl. III z zab.	92	n/z			n/z	n/z	n/z						
Romana zew. K+K	72							D					
Rondo K+G	72				D	D							
Rondo K+K	72		D		D								
Royal K+K	72	n/z			n/z	n/z	n/z						
Royal K+K z zab.	72	n/z			n/z	n/z	n/z						
Space zew. K+P	72							D				D	
Space zew. K+K	72							D				D	
Space zew. K+K	90							D				D	
Space zew. K+K	92							D				D	
Space zew. K+K z zab.	72							D				D	

D - dostępne | n/z - na zamówienie, czas realizacji: 4 tygodnie



Dlaczego AXA?

bo to łatwy w montażu szyld bezpieczny z ochroną cylindra FLEX

1. Masywny, pełny szyld
2. Dekoracyjna osłona wkładki
3. Stalowe zabezpieczenie wkładki chroniące przed jej wyrwaniem
4. Stalowa, obrotowa tarcza antyrozwierceniowa
5. Samoregulujące zabezpieczenie wkładki
6. Stalowe tuleje uniemożliwiające przecięcie śrub (x3)



ISO 9001:2008
ISO 14001:2004
PNC-Nr.
15001/2004
www.axa.com
R 0180025691

EN 1906
EN 1670



AXA Flex Premium ma 3 klasę i 3 stopień bezpieczeństwa zgodnie z EN 1906 i EN 1670

bo to rozwiązanie do drzwi o dużym natężeniu ruchu

Pasuje do drzwi lewych i prawych

Możliwy rozstaw (w mm): 72, 92

Odpowiednie do drzwi o grubości do 110 mm

AXA Flex Premium ma znacząco grubszą sprężynę umiejscowioną w kłamec!

Współpracuje ze wszystkimi typami zamków, również 3-punktowymi

Obrotowa tarcza uniemożliwiająca rozwiercenie

Osłona wkładki z hartowanej stali

Jakość

bo to najlepsze komponenty użyte do produkcji, dzięki którym:

1. Otrzymujemy wysokiej jakości powierzchnię anodowaną
2. Powłoka wykazuje odporność na zarysowania, nie odpryskuje, nie ulega rozwarstwieniu, nie zmienia koloru
3. Wzrasta odporność na korozję oraz warunki atmosferyczne
4. Zachowujemy długi okres eksploatacji

Bezpieczeństwo

bo chwila poświęcona na montaż = = bezpieczeństwo na lata

Oblicz, czy stać Cię, żeby nie mieć drzwi z okuciem 3 Klasy bezpieczeństwa i szyldem bezpiecznym FLEX firmy AXA:

zniszczone drzwi i zabezpieczenia sprzęt RTV i AGD

aparat ze zdjęciami z wakacji kosztowności i pamiątki rodzinne

+ koszty wydania nowych dokumentów

nerwy, stres, stracony czas, pieniądze

FLEX

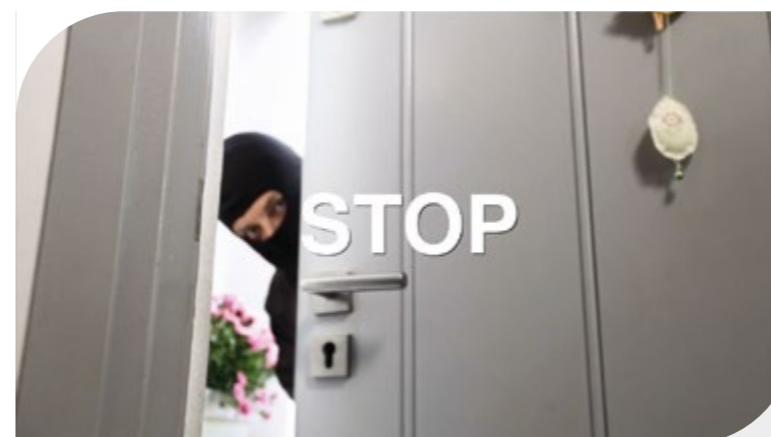

Pamiętaj!

Mniej niż 30 sekund potrzebuje włamywacz, żeby sforsować lub wyrwać wkładkę zamka.

Asortyment FLEX i Premium





Klamki **okienne**



<p>Pluton-0 + zamek</p>  <p>domino</p> <p>F1 F4 F9</p> <p>Netto Brutto Klamka okienna 47,32 58,20</p>	<p>Pluton-0 + zamek</p>  <p>domino</p> <p>biały brąz</p> <p>Netto Brutto Klamka okienna 24,95 30,68</p>	<p>Pluton-0</p>  <p>domino</p> <p>biały brąz</p> <p>Netto Brutto Klamka okienna 5,28 6,49</p>	<p>Pluton-0</p>  <p>domino</p> <p>F1 F4 F9</p> <p>Netto Brutto Klamka okienna 8,85 10,89</p>
<p>Mateo-0</p>  <p>GHIDINI</p> <p>M1/M2 M7/M9</p> <p>Netto Brutto Klamka okienna 79,51 97,79</p>	<p>Roma-0</p>  <p>GHIDINI</p> <p>M1/M2</p> <p>Netto Brutto Klamka okienna 99,19 122,00</p>	<p>Wenus-0</p>  <p>domino</p> <p>biały brąz</p> <p>Netto Brutto Klamka okienna 2,59 3,18</p>	<p>Zita-0</p>  <p>GHIDINI</p> <p>M1/M2 M7/M9</p> <p>Netto Brutto Klamka okienna 127,81 157,20</p>
<p>Secustic-0 T35 do drewna</p>  <p>HOPPE</p> <p>F35 F4 F9</p> <p>Netto Brutto Klamka okienna 19,58 24,08</p>	<p>Secustic-0 T32 do PCV</p>  <p>HOPPE</p> <p>F35 F4 F9</p> <p>Netto Brutto Klamka okienna 19,58 24,08</p>	<p>Secustic-0 z kluczykiem</p>  <p>HOPPE</p> <p>F35 F4 F9</p> <p>Netto Brutto Klamka okienna 93,81 115,38</p>	<p>Secustic-0 z przyciskiem</p>  <p>HOPPE</p> <p>F35 F4 F9</p> <p>Netto Brutto Klamka okienna 83,08 102,19</p>



Akcesoria



Zamek do drzwi szklanych V-100



Rygiel



Przeciwkaseta



Zawias V102



M9

Rączki pasujące do zamka V-100

Aquilla-R
Helena-R
Astoria-R
Delphi-R
Lavinia-R
Hera-RS-R
Lamia-R
Zita-R
Pallas-R
Roma-R

- Zamek bez otworu lub z otworem na wkładkę bębnową.
- Zamek bez klamki w komplecie. Modele klamek pasujące do zamka w tabeli obok.
- Zestaw zawiera: zamek, zawiasy, osłonki na zawiasy i zestaw montażowy.

	Netto	Brutto
Zamek V-100	973,11	1196,93
Zawias V102	256,01	314,89
Rygiel	256,01	314,89
Rygiel	256,01	314,89
Przeciwkaseta	845,06	1039,42

Zamek do drzwi szklanych V-5000



M9

- Zamek bez otworu lub z otworem na wkładkę bębnową.
- Zestaw zawiera: zamek, zawiasy, osłonki na zawiasy i zestaw montażowy.
- Zestaw z klamką Sky w komplecie.

	Netto	Brutto
Zamek + klamka	750,25	922,81

Zamek do drzwi szklanych V-6000



INX

- Zamek bez otworu, z otworem na wkładkę bębnową lub WC.
- Zestaw zawiera: zamek, zawiasy, osłonki na zawiasy i zestaw montażowy.
- Zestaw z klamką Uno w komplecie.

	Netto	Brutto
Zamek + klamka	627,72	772,10
Zamek WC + klamka	785,13	965,71



Pochwyty 092 mosiężny

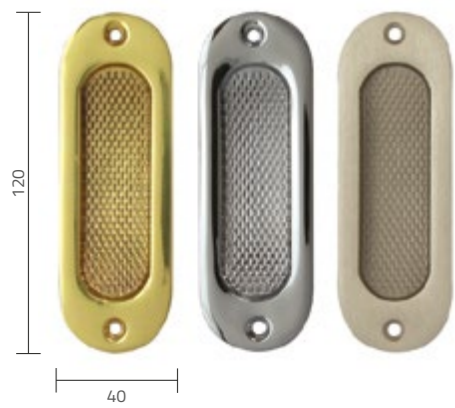

	M1	M6	M9
Netto	28,37	33,25	37,32
Brutto	34,89	40,89	45,90

Pochwyty HOMER 4024

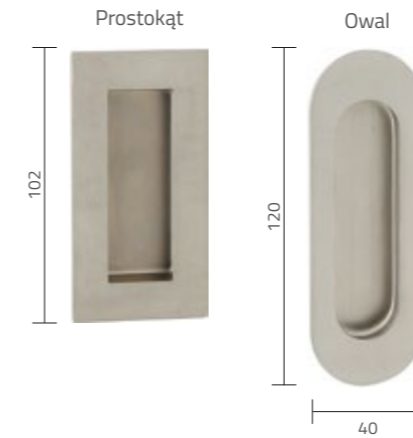

	INX
Netto	11,54
Brutto	14,20

Pochwyty HOMER 3924

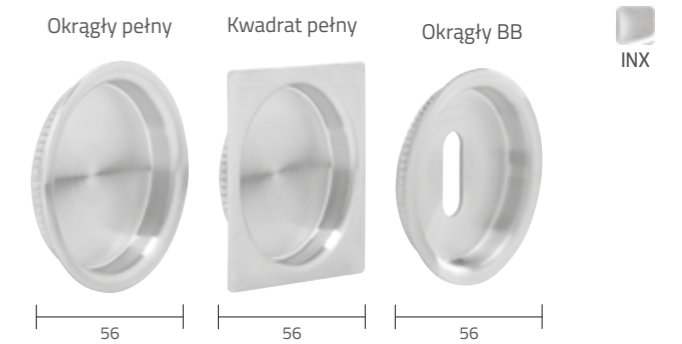

	INX
Netto	11,54
Brutto	14,20

Pochwyty 095 mosiężny



	M1	M3	M4	M6	M9
Netto	25,94	25,94	30,82	30,82	30,82
Brutto	31,91	31,91	37,90	37,90	37,90

Pochwyty 090 ZnAl

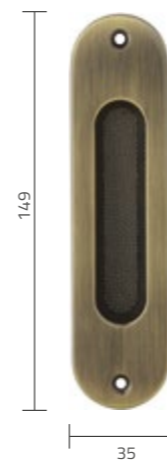

	M3
Netto	30,31
Brutto	37,28

Pochwyty HOMER naparstek

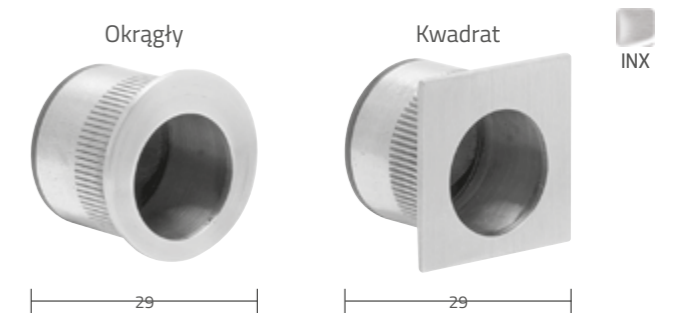

	INX
Netto	5,28
Brutto	6,49

Pochwyty 3524 mosiężny



	M1	M3	M4	M6	M9
Netto	51,14				
Brutto	62,90				

Pochwyty tworzywo



	biały	brąz	złoty	nikiel	orzech jasny
Netto	2,59	2,59	3,49	3,49	2,59
Brutto	3,18	3,18	4,29	4,29	3,18

Pochwyty balkonowy



	M10 antracyt	biały	brąz
Netto	5,28		
Brutto	6,49		



**Tuleje wentylacyjne
Ø 22 mosiężne (szt.)**

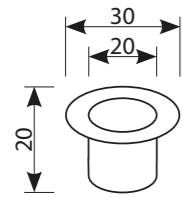

Netto	Brutto
7,95	9,78

**Tuleje wentylacyjne
Ø 30 mosiężne**

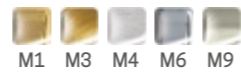
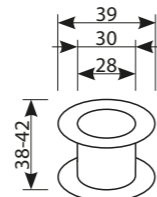

Netto	Brutto
18,68	22,98

**Tuleje wentylacyjne kwadratowe
Ø 40 stalowe, grubość: 38-42 mm**

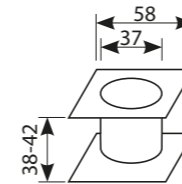

Netto	Brutto
12,92	15,90

**Tuleje wentylacyjne okrągłe Ø 40
stalowe, grubość: 38-42 mm**

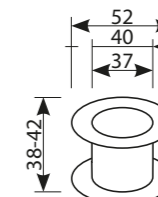

Netto	Brutto
11,31	13,91

**Tuleje wentylacyjne
Ø 35 mosiężne (szt.)**

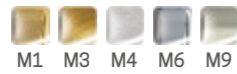
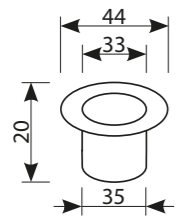

Netto	Brutto
8,85	10,89

**Tuleje wentylacyjne Ø 40
mosiężne, grubość: 35-38 mm**

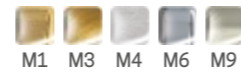
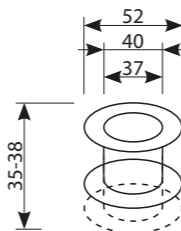

Netto	Brutto
22,27	27,39

**Tuleje wentylacyjne okrągłe Ø 40
stalowe, grubość: 30-40 mm**

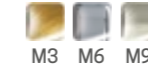
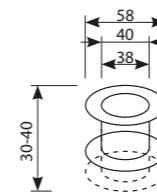

Netto	Brutto
16,15	19,87

**Tuleje wentylacyjne okrągłe Ø 40
stalowe, grubość: 36-46 mm**

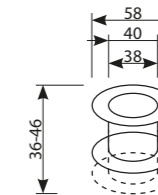

Netto	Brutto
16,15	19,87

**Tuleje wentylacyjne Ø 40
mosiężne, grubość: 38-42 mm**

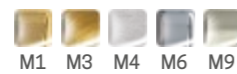
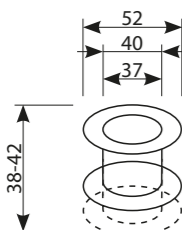

Netto	Brutto
22,27	27,39

Tuleje tworzywo

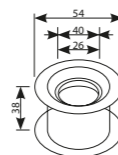

Netto	chrom	złoty	srebrny mat	złoty mat	pozostałe kolory
	2,59	2,59	3,49	3,49	0,88
Brutto	3,18	3,18	4,29	4,29	1,08

**Tuleje wentylacyjne kwadratowe
Ø 40 stalowe, grubość: 36-46 mm**

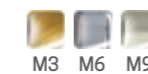
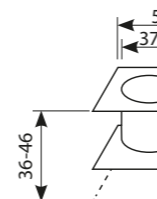

Netto	Brutto
16,15	19,87

**Tuleje wentylacyjne kwadratowe
Ø 40 stalowe, grubość: 30-40 mm**

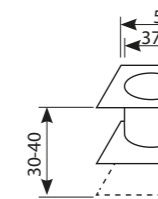

Netto	Brutto
16,15	19,87

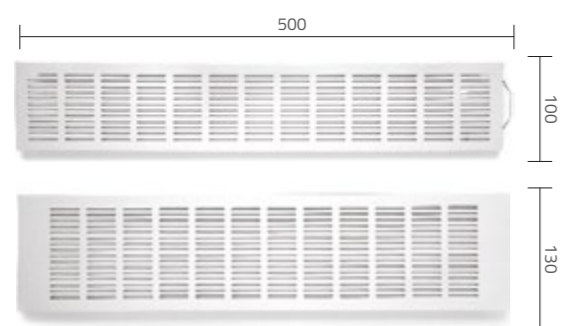
**Kratki wentylacyjne**

	Netto	Brutto
100x500 (szt)	47,83	58,83
130x500 (szt)	51,29	63,09

Oznaczenia WC

Samoprzylepne PCV

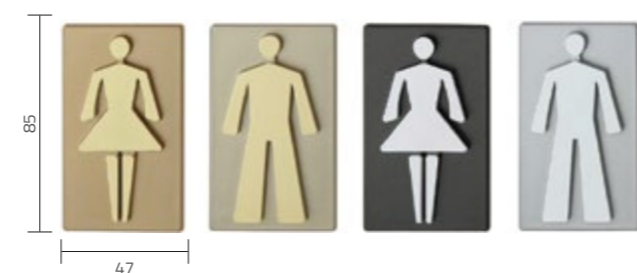

	grafit	oliwka	srebrny	złoty
Netto	9,75	9,75	9,75	9,75
Brutto	11,99	11,99	11,99	11,99

Cyfry INV

Samoprzylepne PCV



	grafit	oliwka	srebrny	złoty
Netto	4,47	4,47	4,47	4,47
Brutto	5,50	5,50	5,50	5,50

Litery INV

Samoprzylepne PCV



	grafit	oliwka	srebrny	złoty
Netto	4,47	4,47	4,47	4,47
Brutto	5,50	5,50	5,50	5,50

Myślniki INV

Samoprzylepne PCV



	grafit	oliwka	srebrny	złoty
Netto	4,47	4,47	4,47	4,47
Brutto	5,50	5,50	5,50	5,50

Oznaczenia WC

Samoprzylepne

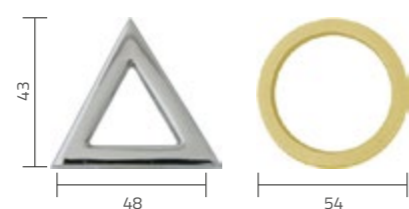

	M1	M6
Netto	8,85	13,32
Brutto	10,89	16,38

Oznaczenie WC

	M1	M6
Netto	11,00	13,32
Brutto	13,53	16,38

Cyfry 5 cm: od 0 do 9

Samoprzylepne



	brąz	M4 M6 SN	patyna złoty
Netto	3,57	4,65	5,36
Brutto	4,39	5,72	6,60

Cyfry 19 cm: od 0 do 9

Samoprzylepne PCV



	czarny
Netto	8,85
Brutto	10,89

Cyfry 10 cm: od 0 do 9

Samoprzylepne



	M1
Netto	19,58
Brutto	24,08

Cyfry 20 cm: od 0 do 9

Samoprzylepne



	M1
Netto	44,63
Brutto	54,89

Elektrozaczepty

Elektrozaczepty R3 z blokadą



Elektrozaczepty R3 z blokadą i pamięcią



Zaczepty płaski długi/krótki

Zaczepty kątowny długi



ocynk srebrny

	Netto	Brutto
Elektrozaczepty R3 z blokadą	74,14	91,19
Elektrozaczepty R3 z blokadą i pamięcią	79,51	97,79
Zaczepty kątowny długi	11,02	13,55
Zaczepty płaski długi/krótki	9,80	12,05



Zamek oszczędnościowy

**domino**

- egl malowany
- chrom

Netto	Brutto
7,95	9,78

Zasuwa AFX

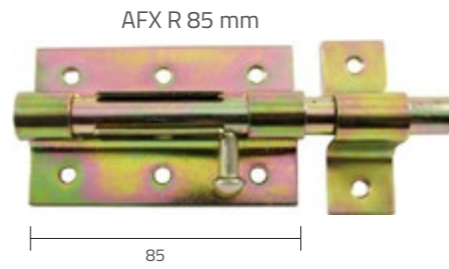
**domino**

- ocynk złoty

	Netto	Brutto
AFX R 70 mm	4,68	5,76
AFX R 85 mm	6,14	7,55
AFX R 100 mm	7,04	8,66
AFX R 120 mm	8,24	10,13
AFX R 140 mm	9,21	11,33

Zamek BODA jednostronny

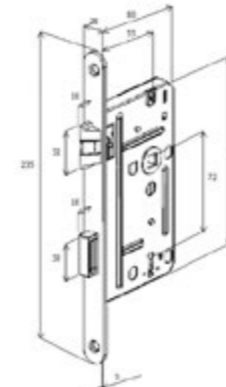
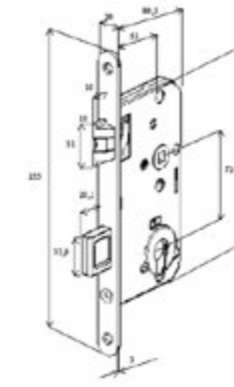
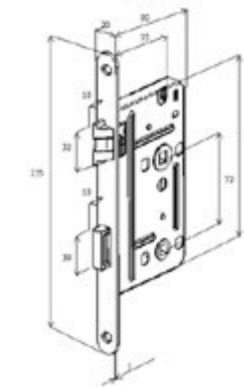
4240 Lewy / prawy
Klucz4242 Lewy / prawy
Wkładka4261 Lewy / prawy
WC

	chrom	egl malowany
Netto	20,48	16,01
Brutto	25,19	19,69

ASSA ABLOY

Zamek hakowy HOMER kwadrat

Zestaw na klucz BB



Zestaw na wkładkę PZ



Zestaw WC



- Zestaw do drzwi przesuwnych zawiera:
- zamek hakowy,
 - komplet szyldów,
 - pochwyt.

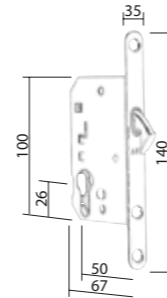

Netto	Brutto
107,23	131,89

HOMER
TESTES U SIĘBIE

Zamek BODA

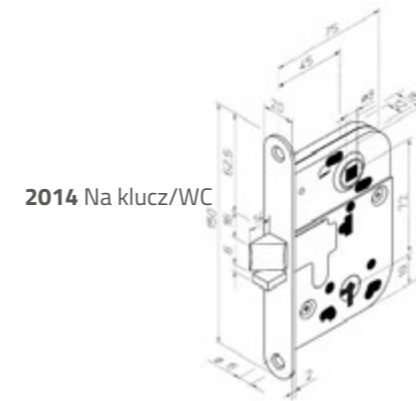

2014 Na klucz/WC

2018 Na wkładkę
bębenkową

- chrom
- egl malowany

	Netto	Brutto
2014 Na klucz/WC	19,58	24,08
2018 Na wkładkę bębenkową	23,17	28,50

ASSA ABLOY

Blachy do zamków (patrz blachy zaczepowe Boda)

Zamek hakowy HOMER okrągły

Zestaw na klucz BB



Zestaw na wkładkę PZ



Zestaw WC



- Zestaw do drzwi przesuwnych zawiera:
- zamek hakowy,
 - komplet szyldów,
 - pochwyt.

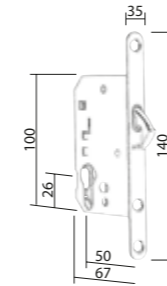

Netto	Brutto
89,34	109,89

HOMER
TESTES U SIĘBIE

Blachy zaczepowe BODA

0028

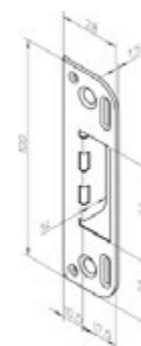

0029

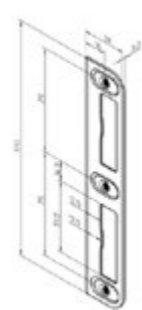

0045



0055

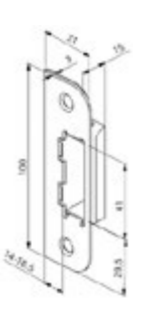

0068

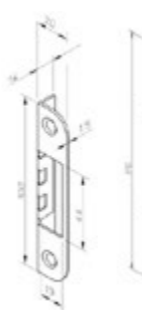

4669

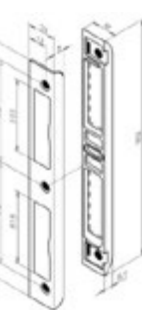

4670

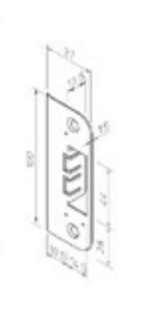

- chrom
- egl malowany

	Netto	Brutto
0028	2,59	3,18
0029	6,18	7,60
0045	2,52	3,10
0068	2,62	3,22
4669	5,20	6,40
0055	4,58	5,64
4670	3,49	4,29

ASSA ABLOY

**Zamek JANIA** + blacha w komplecie

 egl malowany 

Rozstaw		Netto	Brutto
60/50	Klucz	16,01	19,69
	Wkładka	16,01	19,69
	WC	16,01	19,69
72/50	Klucz	18,68	22,98
	Wkładka	18,68	22,98
	WC	18,68	22,98
90/50	Klucz	18,68	22,98
	Wkładka	18,68	22,98
	WC	18,68	22,98

Zamek GERDA ZG**GERDA**

		Netto	Brutto
ZG 100	biały	67,52	83,06
	brąz	67,52	83,06
ZG 200	grafit	67,52	83,06
	brąz	90,63	111,47
ZG 200s	grafit	90,63	111,47
	mosiądz antyczny	97,73	120,21
	nikiel perłowy	97,73	120,21

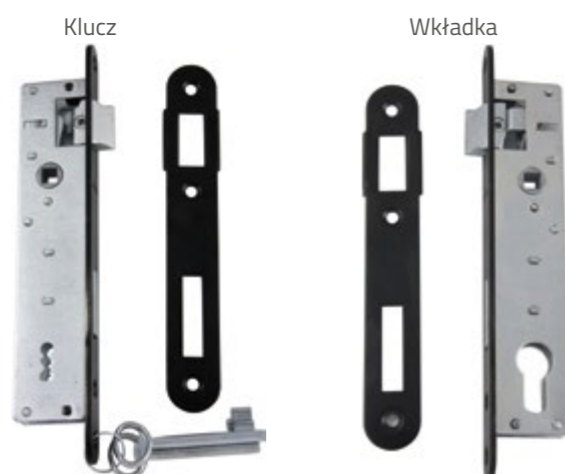
Zamek JANIA bramowy + blacha w komplecie czarny

Rozstaw		Netto	Brutto
90/22	Klucz	20,48	25,19
	Wkładka	18,68	22,98

Zamek GERDA ZN**GERDA**

BRZĄDZ ANTYKOWY I ZAMKI

	Netto	Brutto
	60,50	74,41

Zamek GERDA ZW ocynk srebrny **GERDA**

Rozstaw		Netto	Brutto
60/50	Klucz	25,52	31,39
	Wkładka	25,52	31,39
	WC	25,52	31,39
72/50	Klucz	25,52	31,39
	Wkładka	25,52	31,39
	WC	25,52	31,39
72/55	Klucz	27,24	33,50
	Wkładka	27,24	33,50
	WC	27,24	33,50
90/50	Klucz	27,24	33,50
	Wkładka	27,24	33,50

Zamek GERDA ZX**GERDA**

		Netto	Brutto
ZX 1000	brąz	247,00	303,81
	czarny	247,00	303,81
	grafit	247,00	303,81
	satyna lakier	247,00	303,81
ZX	brąz	261,21	321,29
	czarny	261,21	321,29
	grafit	261,21	321,29
	srebro antyczne	261,21	321,29
	złoty słoneczny	261,21	321,29

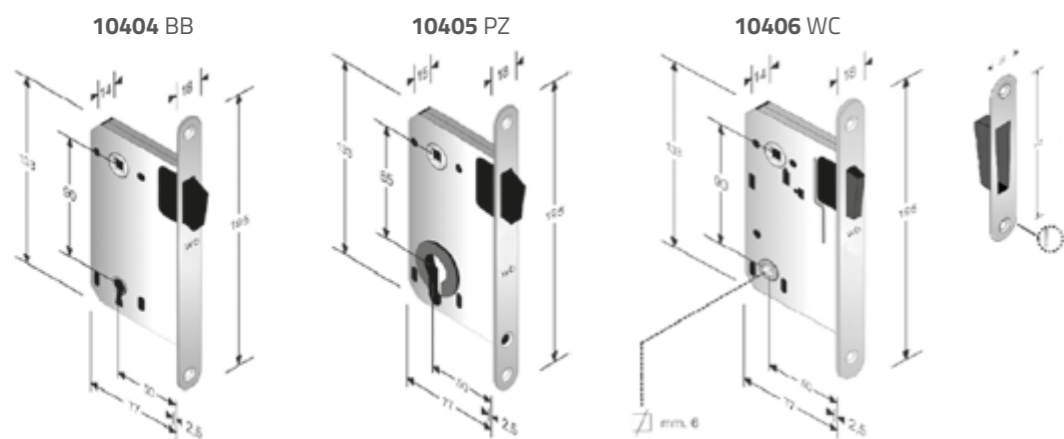

Zamek HOMER

**HOMER**
JESTES U SIEBIE

M9

Netto	Brutto
35,69	43,90

Zamek zawiera w komplecie blachę nieregulowaną do ościeżnicy.

Zamek B-FORTY

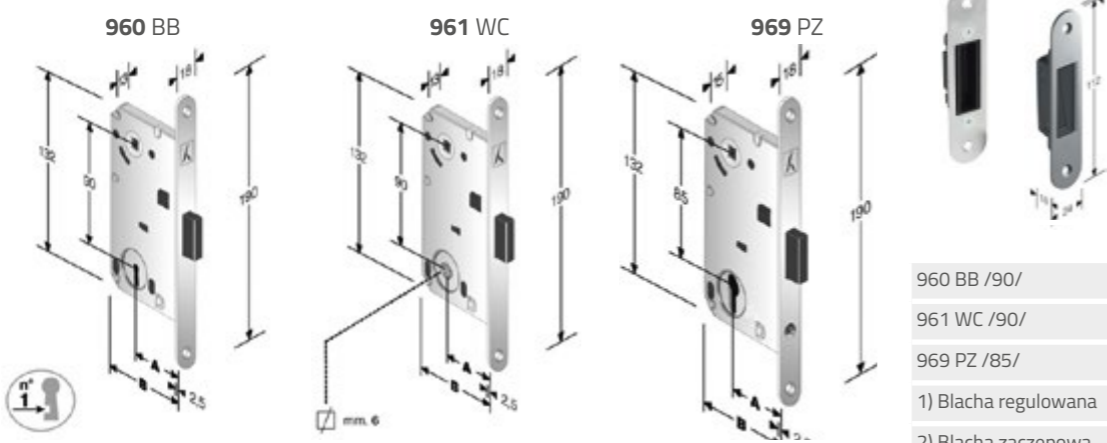
**Bonaiti**

M4

	Netto	Brutto
960 BB / 90/	44,63	54,89
961 WC / 90/	45,52	55,99
969 PZ / 85/	47,32	58,20
1) Blacha regulowana	26,74	32,89
2) Blacha zaczepowa	19,58	24,08

Zamek B-TWO

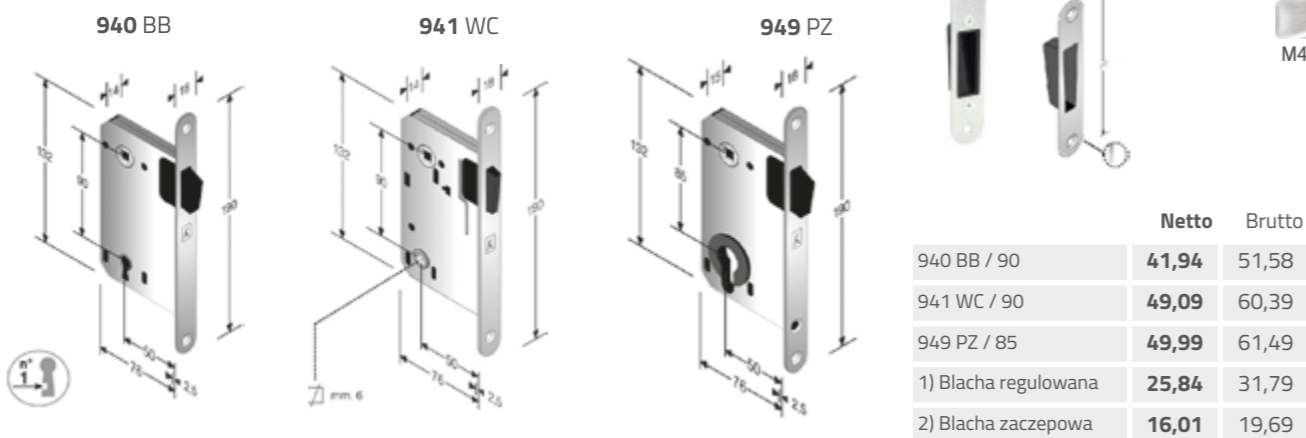
**Bonaiti**

M4

	Netto	Brutto
940 BB / 90	41,94	51,58
941 WC / 90	49,09	60,39
949 PZ / 85	49,99	61,49
1) Blacha regulowana	25,84	31,79
2) Blacha zaczepowa	16,01	19,69

Odbojniki kuliste

**domino**

50

	Netto	Brutto
Odbojnik kulisty przyklejany	7,06	8,68
Odbojnik kulisty	7,06	8,68

Odboje mosiężne

Podłoga niski

domino

M1 M3 M6 M9



Netto	Brutto
18,68	22,98

Odboje mosiężne

Podłoga

domino

M1 M3 M6 M9



Netto	Brutto
18,68	22,98

Odboje mosiężne

Ściana

domino

M1 M3 M6 M9



Netto	Brutto
18,68	22,98

Odboje gumowe

**domino**

	Netto	Brutto
standard	1,69	2,08
medium	7,95	9,78
maxi	27,64	33,99

brąz czarny szary



Odboje tworzywo

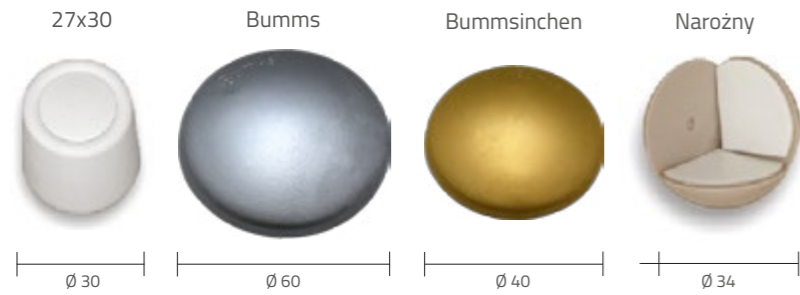

		Netto	Brutto
27x30	beż biały brąz przezroczysty	2,42	2,98
Bumms	beż biały brąz szary srebrny złoty	3,84	4,73
Bummsinchen	beż biały brąz szary srebrny złoty	3,49	4,29
Narożny	beż biały brąz	3,57	4,39

Odboje

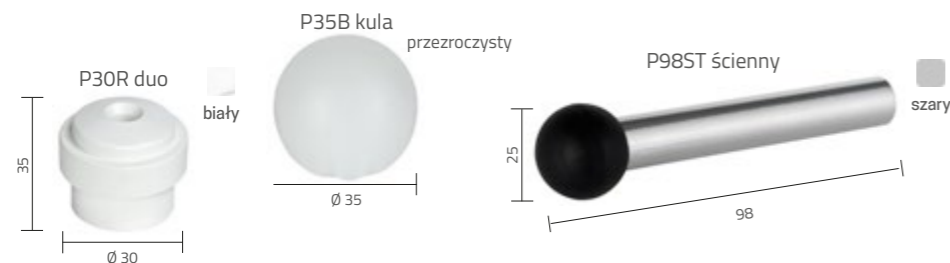
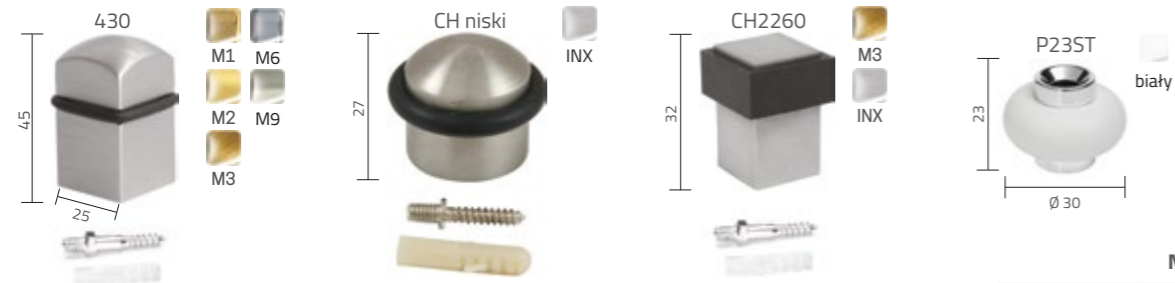
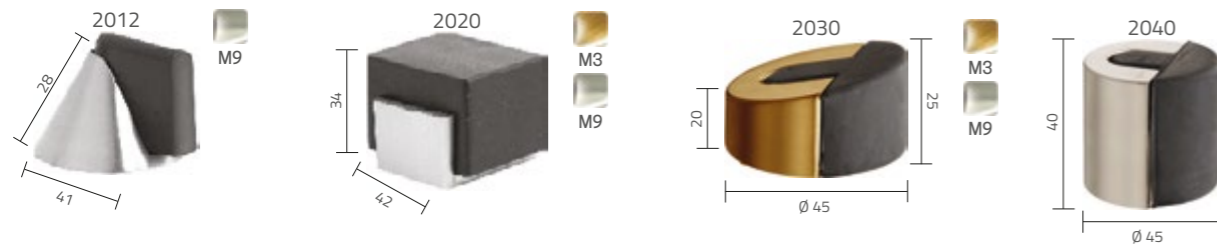

	Netto	Brutto
430	20,48	25,19
2012	16,91	20,80
2020	18,68	22,98
2030	8,85	10,89
2040	10,64	13,09
CH niski	11,54	14,20
CH2260	16,01	19,69
P23ST	9,75	11,99
P38ST	10,64	13,09
P40ST ścienny	17,80	21,90
P84ST ścienny	11,54	14,20
P98ST ścienny	13,32	16,38
P30R duo	3,49	4,29
P35B kula		

Stoper



		Netto	Brutto
Stoper DS-503	brąz grafiatto	29,43	36,20
	nikiel lakierowany		
Stoper DB-04	brąz grafiatto	28,53	35,10
	nikiel lakierowany		
306	mosiądz lakierowany	17,80	21,90
	nikiel lakierowany		

Osłonki zawiasu 13,5 x 80, tworzywo

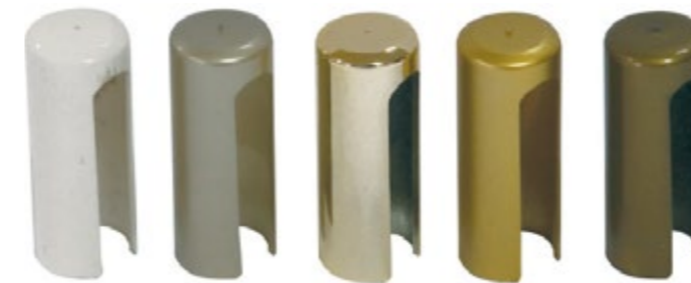

		M1	M2	M3 PAT	M4	M6	M9
Netto	1,17	2,23	2,23	1,17	2,23	2,23	2,23
Brutto	1,44	2,75	2,75	1,44	2,75	2,75	2,75

Osłonki zawiasu, aluminium

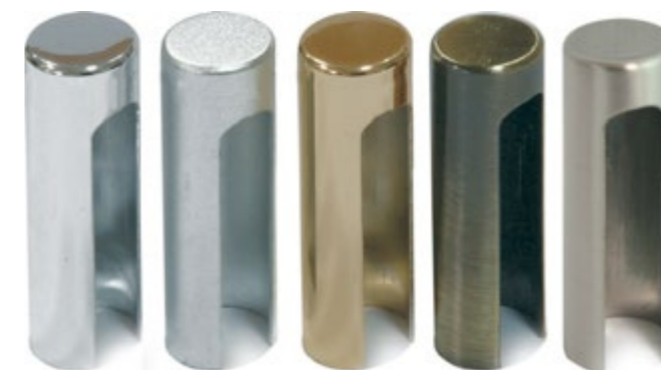

		M1	M3	M4	M6	M9
Ø 14x80	Netto	5,55	5,55	5,55	5,55	5,55
	Brutto	6,83	6,83	6,83	6,83	6,83
Ø 15x82	Netto	5,55	5,55	5,55	5,55	5,55
	Brutto	6,83	6,83	6,83	6,83	6,83
Ø 16x82	Netto	5,80	5,80	5,80	5,80	5,80
	Brutto	7,14	7,14	7,14	7,14	7,14
Ø 20x105	Netto	6,43	6,43	6,43	6,43	6,43
	Brutto	7,91	7,91	7,91	7,91	7,91

Zawias regulowany

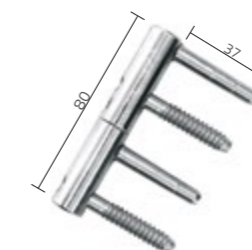

		ocynk złoty	ocynk srebrny
Ø 14 regulowany 14/80 stal	Netto	8,05	8,05
	Brutto	9,90	9,90



Zawias mosiężny

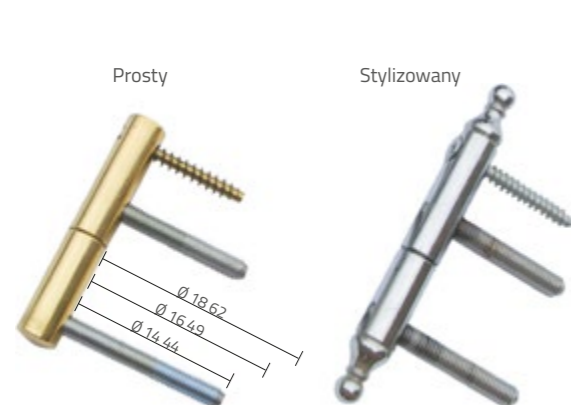

		M1 mosiądz lakierowany	M3 PAT patyna	M4 chrom satynowany	M6 chrom lakierowany
Ø 14 prosty 14/91 mosiądz	Netto	19,43	19,43	19,43	19,43
	Brutto	23,90	23,90	23,90	23,90
Ø 14 stylizowany 14/119 mosiądz	Netto	19,43	19,43	19,43	19,43
	Brutto	23,90	23,90	23,90	23,90
Ø 16 prosty 16/107 mosiądz	Netto	21,87	21,87	21,87	21,87
	Brutto	26,90	26,90	26,90	26,90
Ø 16 stylizowany 16/135 mosiądz	Netto	23,50	23,50	23,50	23,50
	Brutto	28,90	28,90	28,90	28,90
Ø 18 prosty 18/114 mosiądz	Netto	-	29,19	-	-
	Brutto	-	35,90	-	-
Ø 18 stylizowany 18/160 mosiądz	Netto	30,00	30,00	30,00	30,00
	Brutto	36,90	36,90	36,90	36,90

Zawias regulowany

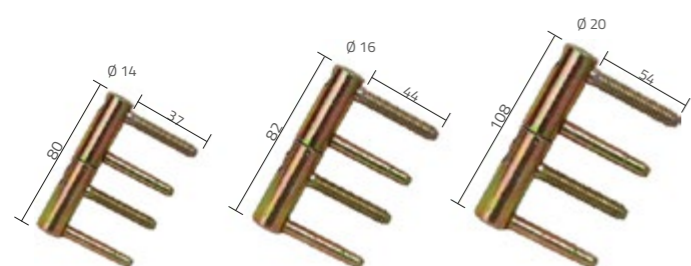

		ocynk srebrny	ocynk złoty
Ø 14 regulowany Exacta 495	Netto	9,67	9,67
	Brutto	11,90	11,90
Ø 16 regulowany Exacta 495	Netto	12,93	12,93
	Brutto	15,90	15,90
Ø 20 regulowany Exacta 495	Netto	18,62	18,62
	Brutto	22,90	22,90

Zawias regulowany

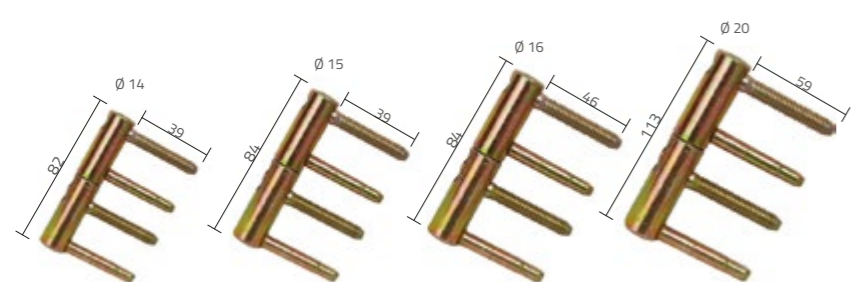

		ocynk złoty
Ø 14 regulowany	Netto	8,86
	Brutto	10,90
Ø 15 regulowany	Netto	12,93
	Brutto	15,90
Ø 16 regulowany	Netto	11,30
	Brutto	13,90
Ø 20 regulowany	Netto	16,99
	Brutto	20,90

Zawias KUBICA

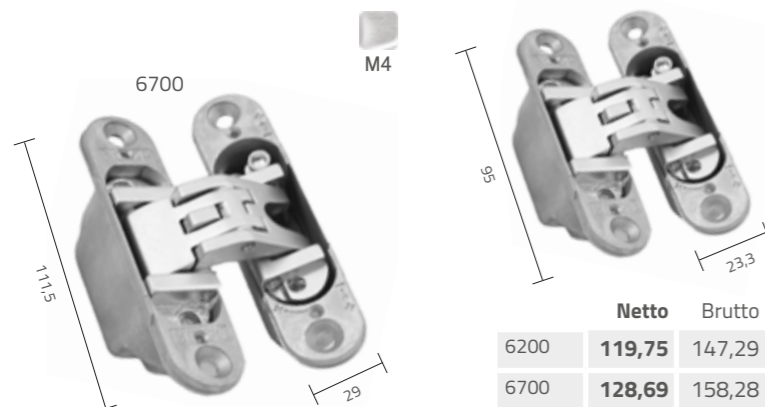

		Netto	Brutto
6200		119,75	147,29
6700		128,69	158,28

Zawias 830

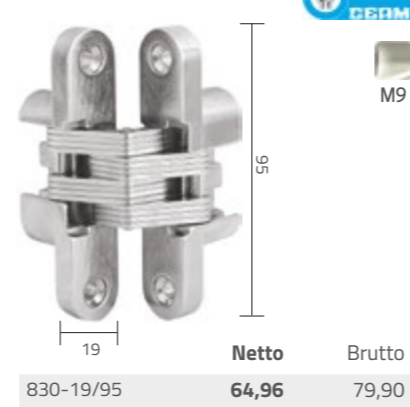

		Netto	Brutto
830-19/95		64,96	79,90

Wizjery

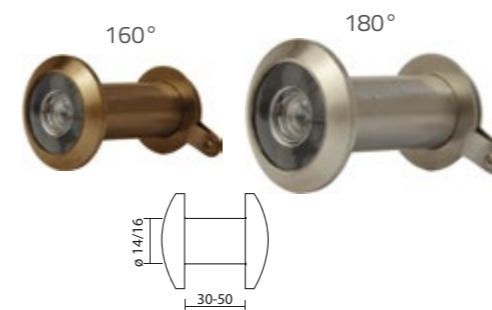

	brąz grafiatto	nikiel lakierowany
Wizjer Ø 14 30/50/160	Netto 7,06	7,06
	Brutto 8,68	8,68
Wizjer Ø 16 30/50/180	Netto 9,75	9,75
	Brutto 11,99	11,99



	Netto	Brutto
LCD	290,16	356,90

Wizjery



		M1	M3	M4	M6	M9
Wizjer Ø 16 40/70/160	Netto	15,11	15,11	-	15,11	-
	Brutto	18,59	18,59	-	18,59	-
Wizjer Ø 16 40/70/200	Netto	20,48	20,48	-	20,48	20,48
	Brutto	25,19	25,19	-	25,19	25,19
Wizjer Ø 16 60/110/200	Netto	20,48	20,48	-	20,48	-
	Brutto	25,19	25,19	-	25,19	-
Wizjer Ø 16 60/92/160	Netto	-	-	20,48	-	-
	Brutto	-	-	25,19	-	-

Zestaw montażowy klamki



	mosiądz lakierowany		brąz grafiatto		nikiel lakierowany	
	Netto	Brutto	Netto	Brutto	Netto	Brutto
120 mm	-	-	6,61	8,13	6,61	8,13
140 mm	6,61	8,13	6,61	8,13	6,61	8,13

Reduktory średnicy pręta WC

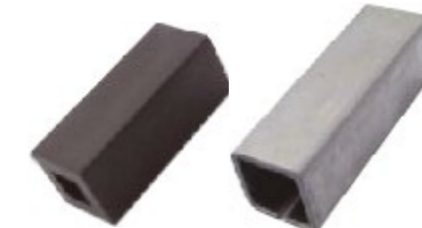

	Netto	Brutto
4/5	1,69	2,08
4/6	1,69	2,08
4/8	1,69	2,08
8/9	1,69	2,08
8/10	1,69	2,08

Pręt kwadratowy

	Netto	Brutto
4x70	1,69	2,08
8x100	3,49	4,29
8x120	3,49	4,29
8x140	3,49	4,29
8x160	4,38	5,39

Śruby przelotowe

	Netto	Brutto
Ø 7,5 (2 szt.)	5,42	6,66

Wkręty do klamek

	Netto	Brutto
3,5x20 (4 szt.)	1,69	2,08

Śrubka imbusowa

	Netto	Brutto
stalowa Ø 5 lub Ø 6	0,81	1,00

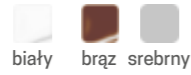
**TS 1000** z ramieniem

Netto Brutto

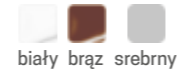
TS 1000 z ramieniem **135,14** 166,22**TS 1500** z ramieniem

Netto Brutto

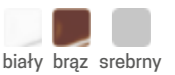
TS 1500 z ramieniem **166,74** 205,09**TS 3000 V** bez szyny

Netto Brutto

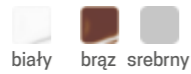
TS 3000 V bez szyny **509,19** 626,30**TS 2000 V** z ramieniem

Netto Brutto

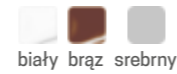
TS 2000 V z ramieniem **190,45** 234,25**TS 1500** z ramieniem z blokadą

Netto Brutto

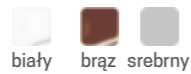
TS 1500 z ramieniem z blokadą **254,55** 313,10**TS 2000 V-BC** z ramieniem

Netto Brutto

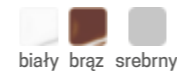
TS 2000 VBC z ramieniem **249,29** 306,62**TS 2000 V** z ramieniem z blokadą

Netto Brutto

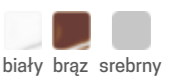
TS 2000 V z ramieniem z blokadą **273,88** 336,87**Szyny ślizgowe**

Netto Brutto

TS 1500 **106,16** 130,57TS 4000/2000 **138,64** 170,53TS 5000/3000 V **107,04** 131,66**Dane techniczne**

	siła wg EN 1154					siła regulowana		maksymalna		regulowana prędkość zamykania w zakresie (stopnie)	regulowana końcowa faza domknięcia w zakresie (stopnie)	tłumienie otwarcia	atest ppoż	montaż po stronie zawiasów na skrzydle	montaż po stronie zawiasów ościeżnicy	montaż na drzwiach całoszklanych
	2	3	4	5	6	plynnie	poprzez przedstawienie	szerokość skrzydła (mm)	waga skrzydła (kg)							
TS 3000 V z szyną ślizgową	x	x	x			x		1100	80	180-15	15-0	x	x	x	x	opcja**
TS 2000 V-BC z szyną ślizgową	x	x	x					1100	80	180-15	15-0	x	x	x	x	opcja**
TS 2000 V-BC z ramieniem blokowanym	x		x	x		x	x	1250	100	180-15	15-0	x	x	x	x	opcja**
TS 2000 V-BC z ramieniem	x		x	x			x	1250	100	180-15	15-0	x	x	x	x	opcja**
TS 2000 V z szyną ślizgową	x	x	x					1100	80	180-15	15-0		x	x	x	opcja**
TS 2000 V z ramieniem blokowanym	x		x	x		x	x	1250	100	180-15	15-0		x	x	x	opcja**
TS 2000 V z ramieniem	x		x	x			x	1250	100	180-15	15-0		x	x	x	opcja**
TS 1500 V z ramieniem blokowanym			x	x			x	1100	80	180-15	15-0		x	x	x	
TS 1500 V z ramieniem			x	x				1100	80	180-15	15-0		x	x	x	
TS 1000 V z ramieniem blokowanym	x	x	x				x	1100	80	180-15	15-0		x*	x	x	
TS 1000 V z ramieniem	x	x					x	1100	80	180-15	15-0		x*	x	x	

* niezalecany do drzwi przeciwpożarowych

** wymagana dodatkowa objęma



Projektowanie systemu

Etap 1

- Przeprowadzenie analizy obiektu i określenie wszystkich pomieszczeń, które mają zostać zabezpieczone systemem. W ten sposób wyznaczony zostaje poziom dostępu klucza generalnego. Projektując system należy dążyć do tego aby wyeliminować lub ograniczyć ilość kluczy, które będą funkcjonowały poza systemem. Oznacza to w praktyce, że należy starać się aby system obejmował wszystkie pomieszczenia.
- Określenie rodzaju zamknięć dla poszczególnych pomieszczeń, (np. wkładka dwustronna, kłódka, wkładka jednostronna).
- Również na tym etapie analizuje się i określa kierunki ewentualnej rozbudowy systemu w przyszłości.

Etap 2

- Określenie wszystkich osób, które będą użytkownikami systemu i sprawdzenie czy na pewno wszyscy zostali ujęci.
- Należy również przeanalizować, czy nie jest konieczne dodanie jako użytkowników osób spoza organizacji (np. pracowników serwisowych, ogrodnika itp.).

Etap 3

- Ustalenie hierarchii dostępu poprzez połączenie użytkowników systemu z pomieszczeniami. Jest to bardzo ważny etap, gdyż to od niego zależą późniejsze uprawnienia użytkowników systemu.
- Ostatnią czynnością jest sprawdzenie poprawności dostępu analizując od strony pomieszczeń i użytkowników.

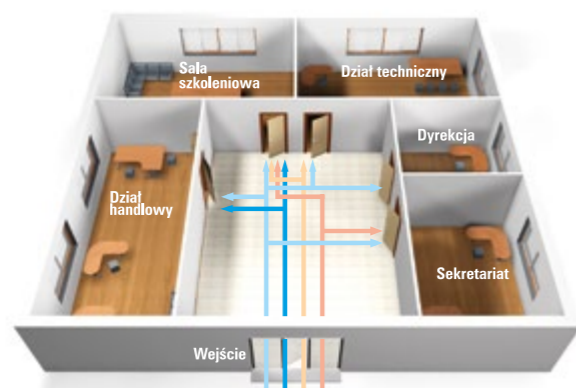

Klucze grupowe		Łość
GHS	Dyrektor	1
HS1	Kierownik działu handlowego	1
HS2	Kierownik działu technicznego	1
HS3	Asystentka	1

Przykładowe rozwiązanie

W tym przykładowym rozwiązaniu w systemie Master Key funkcjonują 4 klucze. Gdyby ten sam obiekt nie był wyposażony w system, do zapewnienia komunikacji, koniecznych byłoby 15 kluczy.

Elektroniczne szyldy drzwiowe i akcesoria

Szyld został zaprojektowany aby zapewnić wysoki poziom zabezpieczenia a jednocześnie dać możliwość zastosowania do różnego rodzaju drzwi. Sprawdza się wszędzie tam gdzie konieczna jest szybka i prosta zmiana dostępu do pomieszczeń dla gości lub personelu. Jest to rozwiązanie bezprzewodowe, niewymagające okablowania. Pozwala na ochronę pojedynczych drzwi lub połączenie wielu drzwi w sieć, w której możliwe jest nadawanie użytkownikom różnych uprawnień i dostępu. Co bardzo ważne, szyld może współpracować ze standardowym zapadkowym zamkiem wpuszczanym.



Przykładowe zastosowania:

Elektroniczne szyldy drzwiowe mogą być stosowane na przykład w hotelach, biurach, magazynach lub innych pomieszczeniach, w których wymagana jest kontrola dostępu.

Dane techniczne:

- Systemy – easyHotel.
- Współpracuje z zamkami o rozstawach – 72 i 92mm.
- Wymiary – 290 x 40 x 20 mm (DxSxG).
- Wskaźnik LED kolorowy, brzęczyk.
- Powierzchnia – stal nierdzewna.
- Zastosowanie – do drzwi o grubości skrzydła 40-120mm.
- Typ baterii – 3 x AAA, 1,5V:
 - alkaliczne: 30.000 otwarć (2 lata)
 - litowe: 50.000 otwarć (3-4 lata)
- Możliwe specjalne wykonania:
 - mosiądz polerowany
 - mosiądz szczotkowany
- Sposób użytkowania:
 - standard
 - automatycznie otwarte na stałe
 - ręcznie otwarcie na stałe
- Temp. użytkowania -20... + 70 °C.
- Stopień ochrony – IP 42 wg EN 60529

TYP-1 / 2 / 4 / 5

Ścienne

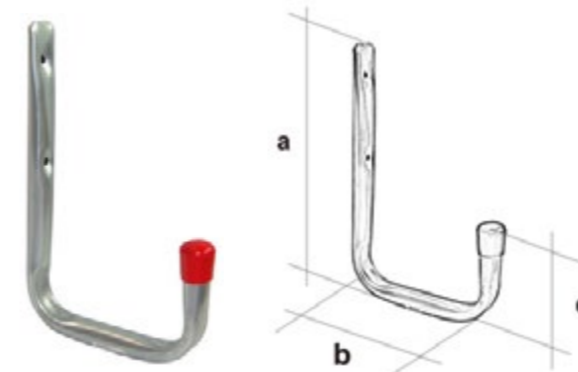

	a	b	c
TYP-1	215	149	90
TYP-2	270	288	92
TYP-4	132	85	50
TYP-5	144	117	52

	Netto	Brutto
D/01 TYP-1 ścienny	5,90	7,25
D/02 TYP-2 ścienny	7,59	9,34
D/04 TYP-4 ścienny	4,18	5,15
D/05 TYP-5 ścienny	4,18	5,15

TYP-3

Sufitowy



TYP-6

Sufitowy

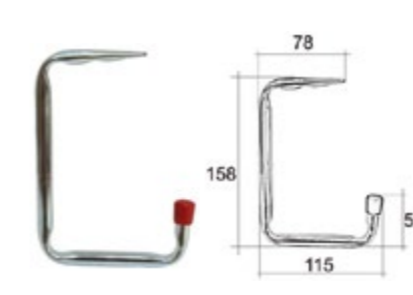

TYP-9

Na rowery

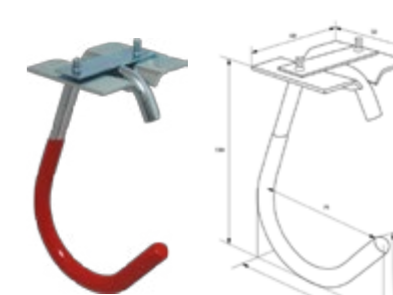

	Netto	Brutto
D/03 TYP-3 sufitowy	24,67	30,34

	Netto	Brutto
D/06 TYP-6 sufitowy	5,90	7,25

	Netto	Brutto
D/09 TYP-9 na rowery	6,74	8,29

TYP-13

Ścienne-sufitowy

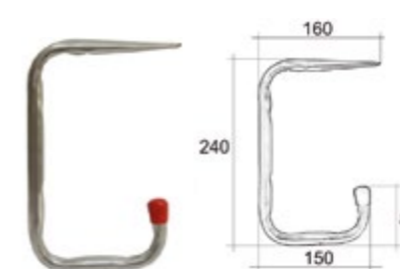

TYP-15

Uniwersalny



TYP-19

Na felgi

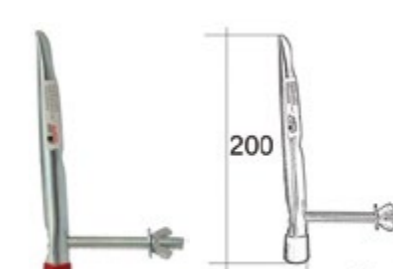

	Netto	Brutto
D/13 TYP-13 ścienne-sufitowy	10,16	12,50

	Netto	Brutto
D/15 TYP-15 uniwersalny	26,38	32,45

	Netto	Brutto
D/19 TYP-19 na felgi	14,43	17,74

**TYP-27 / 28 / 29 / 30**

Prosty podwójny

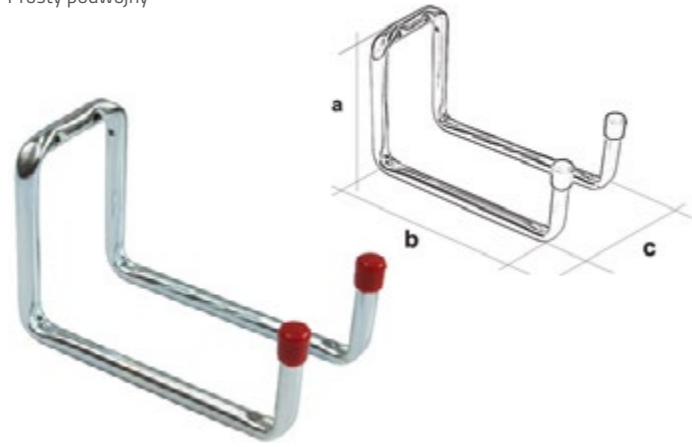

	a	b	c
TYP-27	120	75	90
TYP-28	117	170	90
TYP-29	117	246	90
TYP-30	120	320	90

	Netto	Brutto
D/27 TYP-27 podwójny	11,02	13,55
D/28 TYP-28 podwójny	11,02	13,55
D/29 TYP-29 podwójny	12,71	15,64
D/30 TYP-30 podwójny	14,43	17,74

Zatraskowa mosiądz

Netto Brutto

30-90U141	6,18	7,60
40-90U142	7,95	9,78
60-90U144	17,80	21,90
50-90U143	13,32	16,38

Żeliwna DMO

Netto Brutto

DMO 50	11,54	14,20
DMO 63	16,01	19,69

TYP-33

Na rowery

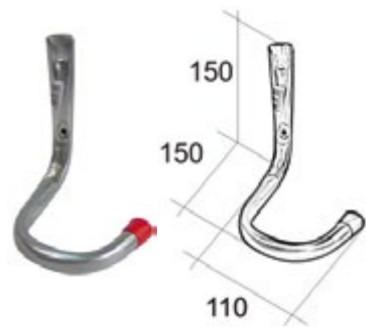

Netto Brutto

D/33 TYP-33 na rowery	9,30	11,44
-----------------------	-------------	-------

TYP-34

Podwójny prosty

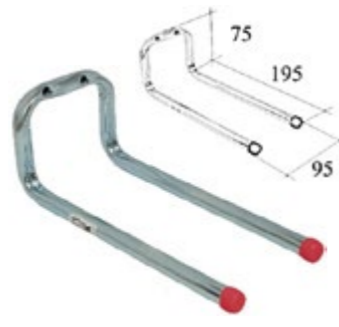

Netto Brutto

D/34 TYP-34 podwójny prosty	7,59	9,34
-----------------------------	-------------	------

TYP-37

Na deskę windsurfing



Netto Brutto

D/37 TYP-37 na deskę windsurfing	13,57	16,69
----------------------------------	--------------	-------

HOMER

Netto Brutto

KZ38	8,85	10,89
KZ45	10,64	13,09
KZ52	12,44	15,30
KZ63	16,91	20,80

B-88 L

Netto Brutto

B-88 L 50mm	11,54	14,20
B-88 L 63mm	15,11	18,59

TYP-40

Na narty

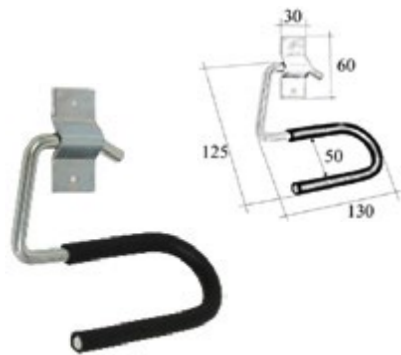

Netto Brutto

D/40 TYP-40 na narty	11,87	14,60
----------------------	--------------	-------

TYP-41 / 42

Na skrzynkę

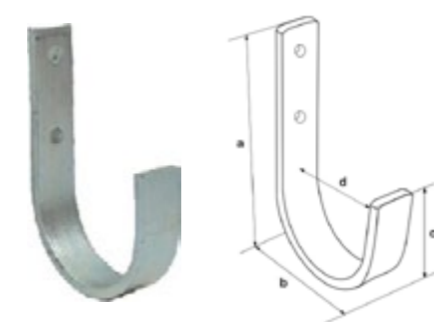

Netto Brutto

	a	b	c	d
TYP-41	115	70	50	60
TYP-42	92	45	30	35

D/41 TYP-41 na skrzynkę	6,74	8,29
D/42 TYP-42 na skrzynkę	6,74	8,29

LS

Netto Brutto

LS R50	45,52	55,99
LS R60	53,56	65,88

SFX

Netto Brutto

SFX R50	15,11	18,59
---------	--------------	-------



Pałkowa

GERDA



	Netto	Brutto
S20	9,75	11,99
S30	15,11	18,59
S40	17,80	21,90
S50	28,53	35,10
S60	34,79	42,80

Pałkowa Long

GERDA



	Netto	Brutto
S40H66	19,58	24,08
S40H80	30,31	37,28

YE3

Yale



niebieski
zielony

	Netto	Brutto
25 mm	13,88	17,07
32 mm	18,45	22,69
38 mm	22,85	28,10

YE3 Long

Yale



niebieski
zielony

	Netto	Brutto
38 mm	23,52	28,93

Y121

Yale



	Netto	Brutto
Y121/40	48,93	60,18
Y121/50	66,68	82,01

Pałkowa wzmocniona

GERDA



	Netto	Brutto
S30	16,01	19,69
S40	21,37	26,29
S50	26,74	32,89
S60	33,00	40,59
S70	41,94	51,58

Trzpieniowa

GERDA



	Netto	Brutto
T50	32,10	39,49
T65	41,06	50,50
T75	50,89	62,59
T90	73,24	90,09

Y220

Yale



	Netto	Brutto
Y220/51	36,57	44,98
Y220/71	57,15	70,30

YP2/23/128/1

Yale



czerwony
srebrny
żółty

	Netto	Brutto
	22,85	28,10

Y150

Yale



	Netto	Brutto
Y150/22	22,34	27,48
Y150/30	25,72	31,64
Y150/40	36,05	44,34

Szyfrowa

HOMER
TESTES U SIĘBIE

	Netto	Brutto
	12,44	15,30

Y110J/15/111/4

Yale



	Netto	Brutto
	50,28	61,84

Active Style

Yale



czerwony
niebieski
srebrny

	Netto	Brutto
	15,06	18,53

Fashion Dreams

Yale



fiolet
niebieski
róż

	Netto	Brutto
	18,95	23,31

Street Style

Yale



czarny
srebrny

	Netto	Brutto
	18,95	23,31

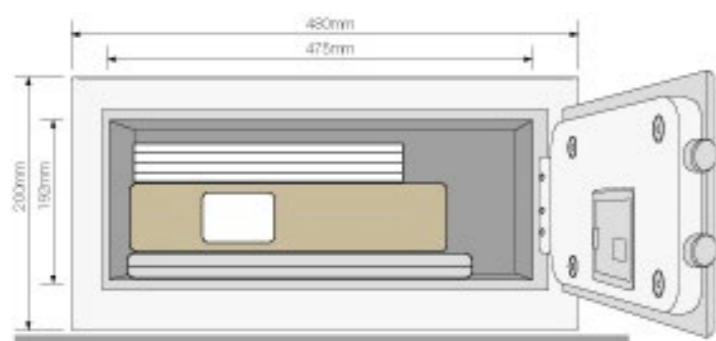

YLM/200/EG1

**Yale****Specyfikacja:**

- elektronicznie sterowane 22 mm rygle,
- 6-zapadkowy dwuryglowy zamek odblokowywany ręcznie,
- 2 klucze w zestawie,
- laserowo wycinane drzwi,
- wzmocnione zawiasy i zamontowana sprężyna otwierająca,
- wzmocnione opancerzenie.

Opis:

- cyfrowa klawiatura i podświetlany na niebiesko wyświetlacz,
- kod użytkownika składający się od 3 do 8 cyfr,
- ostrzeżenie o niskim poziomie baterii,
- funkcja włączania/wyłączania wyświetlania kodu,
- oświetlenie wewnętrzne,
- wymiary: 200 x 480 x 350.

Netto	Brutto
1472,34	1810,98

YSB/250/EB1

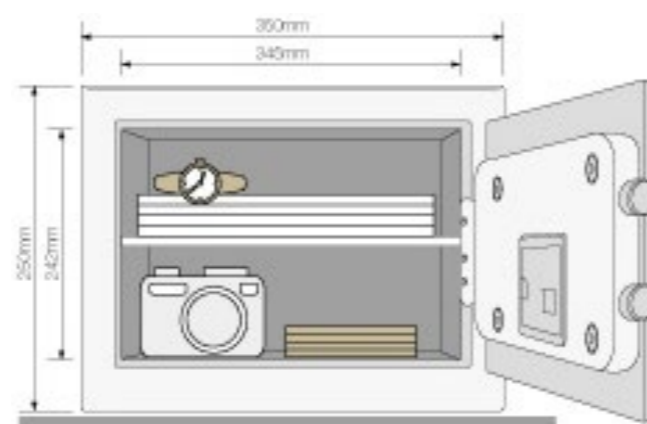
**Yale****Specyfikacja:**

- 22 mm rygle,
- 6-lewarkowy dwuryglowy zamek,
- 2 klucze,
- laserowo wycinane drzwiczki,
- otwory montażowe,
- zbrojone stalowe zaczepy.

Opis:

- cyfrowa klawiatura z wyświetlaczem LCD podświetlanym na niebiesko,
- ostrzeżenie o niskim poziomie baterii,
- funkcja ukrywania wpisywanego kodu,
- wymiary: 250 x 350 x 300.

Netto	Brutto
932,48	1146,95

YLB/200/EB1

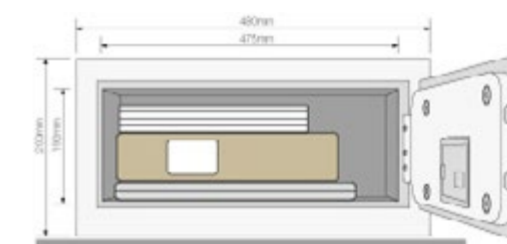
**Yale****Specyfikacja:**

- 22 mm rygle,
- 6-lewarkowy dwuryglowy zamek,
- 2 klucze,
- laserowo wycinane drzwiczki,
- otwory montażowe,
- zbrojone stalowe zaczepy.

Opis:

- cyfrowa klawiatura z wyświetlaczem LCD podświetlanym na niebiesko,
- ostrzeżenie o niskim poziomie baterii,
- funkcja ukrywania wpisywanego kodu,
- wymiary: 200 x 480 x 350.

Netto	Brutto
1042,48	1282,26

YSB/200/EB1

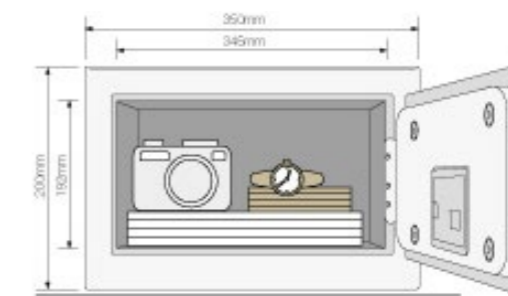
**Yale****Specyfikacja:**

- 22 mm rygle,
- 6-lewarkowy dwuryglowy zamek,
- 2 klucze,
- laserowo wycinane drzwiczki,
- otwory montażowe,
- zbrojone stalowe zaczepy.

Opis:

- cyfrowa klawiatura z wyświetlaczem LCD podświetlanym na niebiesko,
- ostrzeżenie o niskim poziomie baterii,
- funkcja ukrywania wpisywanego kodu,
- wymiary: 200 x 350 x 200.

Netto	Brutto
932,48	1146,95

17K

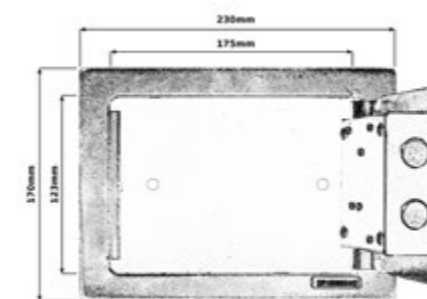
**domino**

Netto	Brutto
135,84	167,09

170x230x170 mm

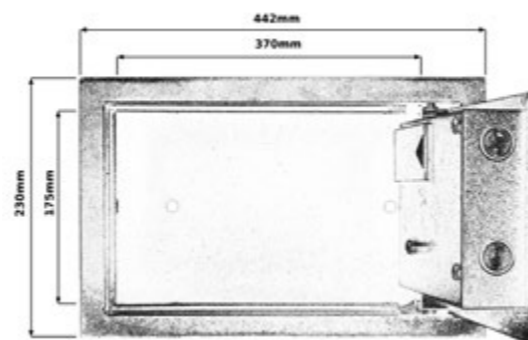
**BH-23 ER**

Netto Brutto

230x442x380 mm **337,06** 414,59**Okno Bulaj**

przykręcany



wklejany

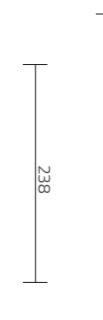

INX

Dostępne wersje z szybą matową lub z szybą przezroczystą.

Netto Brutto

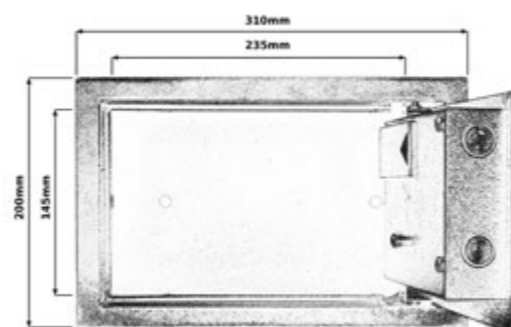
przykręcany **343,33** 422,29wklejany **343,33** 422,29**CH-20 ER**

Netto Brutto

200x310x200 mm **152,84** 187,99**Listwa uszczelniająca ze szczotką 1 mb**

Aluminiowa 24 mm



Samoprzylepna PCV 14 mm



biały, czarny

Netto Brutto

Aluminiowa 24 mm **19,58** 24,08

biały, brąz

dąb, sosna

Netto Brutto Netto Brutto

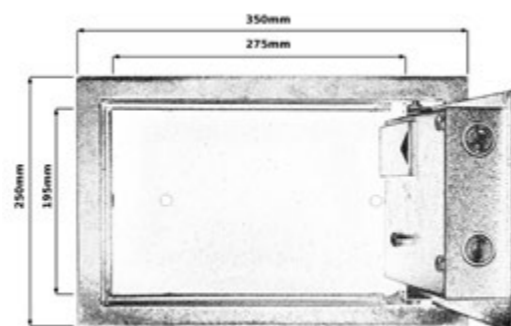
Samoprzylepna PCV 14 mm **15,11** 18,59 **19,58** 24,08Samoprzylepna PCV 24 mm **16,91** 20,80 **20,48** 25,19**CH-25 ER**

Netto Brutto

250x350x250 mm **202,93** 249,60**Listwa uszczelniająca ze szczotką**

Kątowa aluminiowa 1 mb



Netto Brutto

14 mm **18,68** 22,9824 mm **20,48** 25,1934 mm **21,37** 26,29**Listwa uszczelniająca ze szczotką**

Aluminiowa 1 mb



Netto Brutto

14 mm **16,01** 19,6924 mm **17,80** 21,9034 mm **18,68** 22,98



W0713



	M6	M9
Netto	19,40	16,75
Brutto	23,86	20,61

W0714



	M6	M9
Netto	25,61	25,61
Brutto	31,50	31,50

W0715



	M6	M9
Netto	24,72	29,16
Brutto	30,40	35,87

W074H



Netto	21,18
Brutto	26,05

W075H



Netto	21,18
Brutto	26,05

W079H



	M91/M6
Netto	35,35
Brutto	43,48

W0718



	M6	M9
Netto	25,61	30,92
Brutto	31,50	38,04

W0722



	M6	M9
Netto	25,61	29,16
Brutto	31,50	35,87

W0728



	M6	M9
Netto	39,79	43,33
Brutto	48,95	53,30

W011

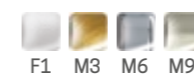

	F1	M3	M6	M9
Netto	7,88	7,88	6,99	7,88
Brutto	9,69	9,69	8,60	9,69

W102



	M3
Netto	4,34
Brutto	5,34

W0808



	M6
Netto	14,98
Brutto	18,42

W0729



	M6	M9
Netto	30,03	24,72
Brutto	36,94	30,40

W5028



Netto	16,75
Brutto	20,61

W5030



Netto	16,75
Brutto	20,61

WHZB01



	M3	M6	M9
Netto	2,57	2,57	2,57
Brutto	3,16	3,16	3,16

WHZB02



	M3	M6	M9
Netto	5,23	5,23	5,23
Brutto	6,44	6,44	6,44

WHZB04



	M3	M6	M9
Netto	3,45	3,45	3,45
Brutto	4,25	4,25	4,25



WHZB06

domino

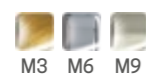

Netto 4,34
Brutto 5,34

Róża

domino



Netto 3,45
Brutto 4,25

Porcelana

domino



Netto 14,98
Brutto 18,42

Skrzynka WP009 domino

Na listy



Netto Brutto
350x130x425 mm 257,47 316,69

Skrzynka WP011 domino

Na listy



Netto Brutto
332x116x425 mm 134,88 165,90

Skrzynka WP013 domino

Na listy



Netto Brutto
352x140x352 mm 234,07 287,90

Z5573

domino

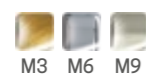

Netto 9,66
Brutto 11,88

Classic

domino

naturalny



Netto 61,95
Brutto 76,19

Modern

domino

naturalny



Netto 61,95
Brutto 76,19

Skrzynka WLD38 domino

Na listy



Netto Brutto
370x103x453 mm 126,91 156,10

Skrzynka WPM34G domino

Na listy



Netto Brutto
410x136x355 mm 126,91 156,10

Skrzynka WPM13G-1 domino

Na listy



Netto Brutto
360x125x315 mm 124,22 152,79

Comfort

domino

biały



Netto 48,65
Brutto 59,84

Popular

domino

biały



Netto 48,65
Brutto 59,84

YJ4036

domino



Netto 77,89
Brutto 95,81

Skrzynka WPM30G domino

Na listy



Netto Brutto
290x130x420 mm 185,94 228,70

Skrzynka WP014 domino

Na listy



Netto Brutto
280x136x327 mm 164,46 202,29

Skrzynka HYBRYDA domino

Na listy



Netto Brutto
180x60x250 mm 28,52 35,07





Skrzynka HPB1402

Na listy

domino



	Netto	Brutto
380x330x110 mm	143,00	175,89

Skrzynka HPB2210

Na listy

domino



	Netto	Brutto
300x340x90 mm	119,75	147,29

Skrzynka HPB2211 domino

Na listy



	Netto	Brutto
300x400x120 mm	133,17	163,80

Skrzynka HPB918 domino

Na listy



	Netto	Brutto
350x430x110 mm	143,00	175,89

Skrzynka HPB918 N domino

Na listy



	Netto	Brutto
350x320x110 mm	133,17	163,80

Apteczka ścienna

domino



	Netto	Brutto
300x248x110 mm	86,67	106,60

Skrzynki na klucze

domino



	Netto	Brutto
96 kluczy 250x180x80 mm	89,34	109,89
48 kluczy 300x240x80 mm	53,56	65,88
20 kluczy 200x150x80 mm	44,63	54,89

Szafa S 01



Szafa akcesoria



Szafa S 03



Szafa S 02



Ekspozytor S 06



Ekspozytor S 07



Plansza S 03



Planet



- wymiary szaf dostosowane do potrzeb Klienta
- ilość przegródek do uzgodnienia
- standardowa szafa o wymiarach: 1970x1320x500
- plansze ekspozycyjne S03 robione pod indywidualne zamówienie

KLAMKI WEWNĘTRZNE

Klamki na dzielonym szyldzie kwadratowym

Alma-QR	19
Baltic-QR	19
Coral-QR	19
Cube-RT	19
Ene-QR	19
Eris-QR	19
Figó-QR	19
Fokus-QR	20
Fero-QR	21
Fremo-QR	21
Galaxy-QR	21
Gustaw-QR	21
Insignia-QR	21
Jane-QR	21
Jaro-QR	21
Jaro-QR eco	21
Joon-QR	22
Kyrk-QR	22
Line-RT	22
Logo-QR	23
Maff-QR	23
Milano-QR	23
Modena-QR	23
Minimal-RT	24
Net-QR	24
Omega-QR	24
Palermo-QR	24
Quanta-QR	25
Qubik-QR	25
Presto-QR	26
Real-QR	26
Romana-QR	26
Sky-QR	26
Stuu-QR	26
Time-QR	26
Tre-QR	26
Twist-RT	26

Klamki na dzielonym szyldzie kwadratowym PREMIUM

Andy-QR	28
Biblo-QR	28
Delux-QR	29
Electra-QR Cristal	29
Etar-QR	30
Frame-QR	30
Gazela-QR	31

Helena-QR	31
Jezz-QR	32
Limone-QR	32
Liva-QR	33
Magnet-QR	33
Maya-QR	34
Maya-QR Cristal	34
Miami-QR	35
Navy-QR	35
Pira-QR	36
Quezo-QR	36
Rainbow-QR	37
Sedar-QR	37
Tiger-QR	38
Tora-QR	38
Toro-QR	39
Vertigo-QR	39
Yoda-QR	40

Klamki na dzielonym szyldzie okrągłym

Afrodyta-R	42
Alma-R eco	42
Ballen-R	42
Bilbao-R	42
Biszkopt-R	42
Capri-R	42
Casablanca-R	42
Econom-R	42
Dekan-R	43
Elizabeth-R	43
Ellegant-R	43
Enigma-R	43
Fly-R eco	43
Fokus-R	43
Galaxy-R	43
Ibis-R	44
Insignia-R	44
Jane-R	44
Jane-R AG1	44
Jaro-R	44
Jaro-R eco	44
Jola-R	44
Kyrk-R	44
Lavia-R	44
Loft-R	45
Ludwik-R	45
Marion-R	45
Pro-R	45
Malta-R	46
Modena-R	46
Monaco-R	46
Nova-R	46
Omega-R	47
Onyks-R	47

Oslo-R	47
Otto-R	47
Petra-R	48
Presto-R	48
Rio-R	48
Romana-R	48
Sharon-R eco	48
Tiger-R	48
Snap-R	49
Time-R	49
Wing-R	49

Klamki na dzielonym szyldzie okrągłym PREMIUM

Apollo-R	51
Aquilla-R	51
Astoria-R	52
Aurea-R	52
Bali-R	53
Delphi-R	53
Delux-R	54
Duncan-R	54
Frost-R	55
Gran Pix-R	55
Helena-R	56
Hera-R-RS	56
Ikko-R	57
Iris-R	57
Klotho-R	58
Lady-R Cristal	58
Lamia-R	59
Lavinia-R	59
Lavinia-R Cristal	60
Leonardo-R	60
Liva-R	61
Matteo-R	61
Morfeo-R	62
Pallas-R	62
Pira-R	63
Roma-R	63
Polaris-R	64
Skin-R	65
Snake-R	65
Tora-R	66
Toro-R	66
Tuluza-R	67
Valentina-R	67
Venus-R	68
Zita-R	68

Klamki na długim szyldzie

Afrodyta	70
Alma eco	70
Atena	70
Ballen	70

Bilbao	70
Biszkopt	70
Capri	70
Casablanca	70
Econom	70
Dekan	71
Enigma	71
Fero	71
Figó	71
Elizabeth	72
Fly eco	72
Fokus	72
Ibis	72
Insignia	73
Jane	73
Jaro	73
Jaro eco	73
Jola	73
Kyrk	73
Loft	73
Malta	73
Monaco	73
Nova	74
Omega	74
Oslo	74
Otto	74
Petra	74
Presto	74
Pro	74
Real	74
Rio	74
Romana	75
Sharon eco	75
Tiger	75
Tre	75
Wing	75

Klamki na długim szyldzie PREMIUM

Apollo	77
Atene	77
Bali	77
Infinita	77
Tuluza	78
Valentina	78
Venus	78

Klamki ze stali nierdzewnej

Agnessa-QR	80
Grisza-QR	80
Jane-QR	80
Liu-R	80
Luka-QR	80
Padwa-R	80
Prado-R	81
Romana-QR	81

Romana-R	81
Siena-R	81
Sigma-QR	82
Sigma-R	82
Sigma-R Owal	82
Uno	82
Uno 170	82
Uno 170 Gałka	82
Uno Gałka	82
Uno-R	82
Uno-R Owal	82

Klamki na dzielonym szyldzie slim

Insignia-QR	84
Insignia-R	84
Jane-QR	84
Jane-R	84
Padwa-R	85
Siena-R	85
Jaro-QR eco	86
Jaro-R eco	86
Liu-R	86
Prado-R	86
Presto-QR	86
Presto-R	86
Sigma-QR	86
Sigma-R	86
Uno-R	86

Szyldy wewnętrzne

0006 Plus	88
10710	88
950	88
EF Owal	88
Owalny Plus	88
900	89
980	89
Alma-QR	89
Biszkopt-R	89
Econom-R	89
EF 200	89
EF Lui-R	90
EF SN04-QR	90
Jane-R AG1	90
KW-QR	90
Quadro-QR	90
Quadro-QR M6/M9	90
Pro-R	91
Quanta-QR	91
RT	91
Slim-QR	91
Slim-R	91
Tiger-R	91
0003/6065	92
546-Q	92

555	92
6060	93
Oro-QR	93
Oro-R	93

Gałki

2055-R	95
2065-QR	95
2075-R	95
AT-R eco	95
6711 Prosta	96
6871 Kula	96
Apollo-R + gałka	96
Linoza-R	97
Skin-R	97

KLAMKI DO DRZWI ZEWNĘTRZNYCH

Alma zew. K+K	99
Fokus zew. K+K	99
Fokus zew. K+P	99
Galaxy zew. K+K	99
Haga K+K	99
Jane zew. K+K	100
Lana K+K	100
Lana K+P	100
Manitoba K+K	100
Omega zew. K+K	100
Niagara K+K	101
Niagara K+P	101
Ottawa K+K	101
Romana zew. K+K	101
Prestige K+G	102
Prestige K+G z zab.	102
Prestige K+K	102
Prestige K+K z zab.	102
Royal K+K	103
Royal K+K z zab.	103
Space zew. K+K	103
Space zew. K+K z zab.	103
Space zew. K+P	103
Ares	104
Hades P18	104
Rondo K+G	104
Rondo K+K	104

KLAMKI OKIENNE

Mateo-O	109
Pluton-O	109
Pluton-O	109
Pluton-O	109
Pluton-O	109
Roma-O	109
Secustic-O	109
Secustic-O	109
Secustic-O	109
Secustic-O	109
Wenus-O	109
Zita-O	109

AKCESORIA

Zamki do drzwi szklanych

Zamek do drzwi szklanych V-100	111
Zamek do drzwi szklanych V-5000	111
Zamek do drzwi szklanych V-6000	111

Pochwyty do drzwi przesuwanych

Pochwyty 092 mosiężny	112
Pochwyty 095 mosiężny	112
Pochwyty 3524 mosiężny	112
Pochwyty 090 ZnAl	113
Pochwyty balkonowy	113
Pochwyty HOMER 3924	113
Pochwyty HOMER 4024	113
Pochwyty HOMER naparstek	113
Pochwyty tworzywo	113

Tuleje wentylacyjne

Tuleje tworzywo	114
Tuleje wentylacyjne Ø 22 mosiężne (szt.)	114
Tuleje wentylacyjne Ø 30 mosiężne	114
Tuleje wentylacyjne Ø 35 mosiężne (szt.)	114
Tuleje wentylacyjne Ø 40 mosiężne, grubość: 35-38 mm	114
Tuleje wentylacyjne Ø 40 mosiężne, grubość: 38-42 mm	114
Tuleje wentylacyjne kwadratowe Ø 40 stalowe, grubość: 30-40 mm	115
Tuleje wentylacyjne kwadratowe Ø 40 stalowe, grubość: 36-46 mm	115
Tuleje wentylacyjne kwadratowe Ø 40 stalowe, grubość: 38-42 mm	115
Tuleje wentylacyjne okrągłe Ø 40	

stalowe, grubość: 30-40 mm	115
Tuleje wentylacyjne okrągłe Ø 40 stalowe, grubość: 36-46 mm	115
Tuleje wentylacyjne okrągłe Ø 40 stalowe, grubość: 38-42 mm	115

Cyfry i oznaczenia

Cyfry 10 cm: od 0 do 9	116
Cyfry 19 cm: od 0 do 9	116
Cyfry 20 cm: od 0 do 9	116
Cyfry 5 cm: od 0 do 9	116
Kratki wentylacyjne	116
Oznaczenia WC	116
Oznaczenia WC	116
Oznaczenia WC	116
Cyfry INV	117
Litery INV	117
Mysliniki INV	117

Akcesoria

Elektrozaczepy	117
Zamek oszczędnościowy	118
Zasuwa AFX	118

Zamki hakowe

Zamek hakowy HOMER kwadrat	118
Zamek hakowy HOMER okrągły	118

Blachy zaczepowe

Blachy zaczepowe BODA	119
-----------------------	-----

Zamki

Zamek BODA	119
Zamek BODA jednostronny	119
Zamek GERDA ZW	120
Zamek JANIA	120
Zamek JANIA bramowy	120
Zamek GERDA ZG	121
Zamek GERDA ZN	121
Zamek GERDA ZX	121

Zamki magnetyczne

Zamek B-FORTY	122
Zamek B-TWO	122
Zamek HOMER	122

Odboje

Odboje gumowe	123
Odboje mosiężne	123
Odboje mosiężne	123
Odboje mosiężne	123
Odbojniki kuliste	123
Odboje	124
Odboje tworzywo	124

Ostonki

Ostonki zawiasu 13,5 x 80, tworzywo	125
Ostonki zawiasu, aluminium	125

Stopery

Stopery	125
---------	-----

Zawiasy

Zawias regulowany	125
Zawias 830	126
Zawias KUBICA	126
Zawias mosiężny	126
Zawias regulowany	126
Zawias regulowany	126

Akcesoria

Pręt kwadratowy	127
Reduktory średnicy pręta WC	127
Wkręty do klamek	127
Zestaw montażowy klamki	127
Śrubka imbusowa	127
Śruby przelotowe	127

Wizjery

Wizjery	127
Wizjer LCD	127

Samozamykacze

TS 1000	128
TS 1500	128
TS 1500	128
TS 2000 V	128
TS 2000 V	128
TS 2000 V-BC	128
Szyny ślizgowe	129
TS 3000 V	129

Kołatki

Kołatka CH Barocco	130
Kołatka CH Tondo	130
Kołatka Victorian	130

Wkładki

Wkładki DMO dwustronna	131
Wkładki DMO z gałką	131
Wkładki DMO zestaw wkładek	131
ECOLINE K5	132
Wkładka GERDA PROSYSTEM	132
Wkładka GERDA WKE1	132
Wkładki bębnekowe	133
Zestaw wkładek jednakowo kodowanych	134

Haki garażowe

TYP-1 / 2 / 4 / 5	137
TYP-13	137
TYP-15	137
TYP-19	137
TYP-3	137
TYP-6	137
TYP-9	137
TYP-27 / 28 / 29 / 30	138
TYP-33	138
TYP-34	138
TYP-37	138
TYP-40	138
TYP-41 / 42	138

Kłódki

B-88 L	139
HOMER	139
LS	139
SFX	139
Zatraskowa mosiądz	139
Żeliwna DMO	139
Pałatkowa	140
Pałatkowa Long	140
Pałatkowa wzmocniona	140
Szyfrowa	140
Trzpieniowa	140
Y110J/15/111/4	140
Active Style	141
Fashion Dreams	141
Street Style	141
Y121	141
Y150	141
Y220	141
YE3	141
YE3 Long	141
YP2/23/128/1	141

Sejfy

YLM/200/EG1	142
YSB/250/EB1	142
17K	143
YLB/200/EB1	143
YSB/200/EB1	143
BH-23 ER	144
CH-20 ER	144
CH-25 ER	144

Bulaj

Okno Bulaj	145
------------	-----

Listwy

Listwa uszczelniająca ze szczotką	145
Listwa uszczelniająca ze szczotką 1 mb	145

Wieszaki

W0713	146
W0714	146
W0715	146
W0718	146
W0722	146
W0728	146
W0729	146
W5028	146
W5030	146
W011	147
W074H	147
W075H	147
W079H	147
W0808	147
W102	147
WHZB01	147
WHZB02	147
WHZB04	147
Classic	148

Comfort	148
Modern	148
Popular	148
Porcelana	148
Róża	148
WHZB06	148
YJ4036	148
Z5573	148

Skrzynki

Skrzynka HYBRYDA	149
Skrzynka WLD38	149
Skrzynka WPO09	149
Skrzynka WPO11	149
Skrzynka WPO13	149
Skrzynka WPO14	149
Skrzynka WPM13G-1	149
Skrzynka WPM30G	149
Skrzynka WPM34G	149
Apteczka ścienna	150
Skrzynka HPB1402	150
Skrzynka HPB2210	150
Skrzynka HPB2211	150
Skrzynka HPB918	150
Skrzynka HPB918 N	150
Skrzynki na klucze	150

Formy ekspozycji

Ekspozytor S 06	151
Ekspozytor S 07	151
Planet	151
Plansza S 03	151
Szafa akcesoria	151
Szafa S 01	151
Szafa S 02	151
Szafa S 03	151



A series of 25 horizontal lines, evenly spaced, filling the majority of the page. These lines are intended for writing or drawing.

Formy przebić



Otwór na klucz



Otwór na wkładkę bębnekową



WC blokada

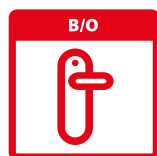

Bez otworu



Klamka dzielona



Klamka okienna

Kombinacje



BB

Klamka/
klamka na klucz

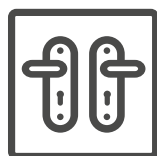

PZ

Klamka/
klamka na wkładkę bębnekową



B/O

Klamka/
klamka bez otworu

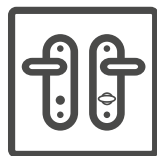

K+K WC P

Klamka/
klamka blokada WC prawa

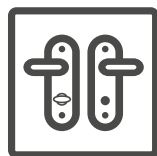

K+K WC L

Klamka/
klamka blokada WC lewa



K+G Zew PZ L

Klamka/
gałka zewnętrzna PZ lewa



K+G Zew PZ P

Klamka/
gałka zewnętrzna PZ prawa



K+K Zew PZ P

Klamka/
klamka zewnętrzna PZ prawa



K+K Zew PZ L

Klamka/
klamka zewnętrzna PZ lewa



-R

Klamka dzielona na rozecie okrągłej



-QR

Klamka dzielona na rozecie kwadratowej



-O

Klamka okienna

Kolory

M1		Mosiądz lakierowany
M2		Mosiądz satynowany
M3		Brąz grafiatto
M3 MAT		Brąz mat
M4		Chrom satynowany
M6		Chrom lakierowany
M7		Chrom perłowy
M8		Tytan
M9		Nikiel lakierowany
M10		Brąz złoty
M91		Nikiel satyna velvet
M95		Nikiel antyczny
M18		Chrom satynowany nielakierowany
M50		Chrom satyna
M75		Brąz antyk
INX		Stal nierdzewna
SN		Nikiel satynowany
F1		Srebrny mat anodowany
F2		Szampański mat anodowany
F3		Złoty mat anodowany
F4		Brąz mat anodowany
F6 INX		Stal nierdzewna
F9		Tytan anodowany

Łączenia kolorów

M1/M2	Mosiądz lakierowany/mosiądz satyna
M50/M6	Chrom satyna/chrom lakierowany
M6/M18	Chrom lakierowany/chrom satynowany nielakierowany
M6/M9	Chrom lakierowany/nikiel lakierowany
M6/M50	Chrom lakierowany/chrom satyna
M7/M9	Chrom perłowy/nikiel lakierowany
M6/white	Chrom lakierowany/biały
M6/antracyt	Chrom lakierowany/antracyt



Region A

d.nowacki@domino.pl

+48 601 770 498

+48 74 667 04 12

Region B

r.zajac@domino.pl

+48 609 830 644

+48 74 832 32 52

Region C

j.lysiak@domino.pl

+48 605 256 868

+48 74 667 04 16

Region D

s.wiewior@domino.pl

+48 603 508 923

+48 74 832 48 07

Region E

s.sas@domino.pl

+48 601 141 556

+48 74 832 10 11

DOMINO POLSKA

ul. Rzeźnicza 4
58-200 Dzierżoniów
tel. **+48 74 832 32 37**
fax **+48 74 660 79 78**
hurt@domino.pl
www.domino.pl