

CAMELEON

SYSTEM

Nowodvorski
LIGHTING

Light for your home
Since 1994

Nowodvorski
L I G H T I N G

CAMELEON SYSTEM

UNLIMITED POSSIBILITIES
NIEOGRANICZONE MOŻLIWOŚCI
НЕОГРАНИЧЕННЫЕ ВОЗМОЖНОСТИ

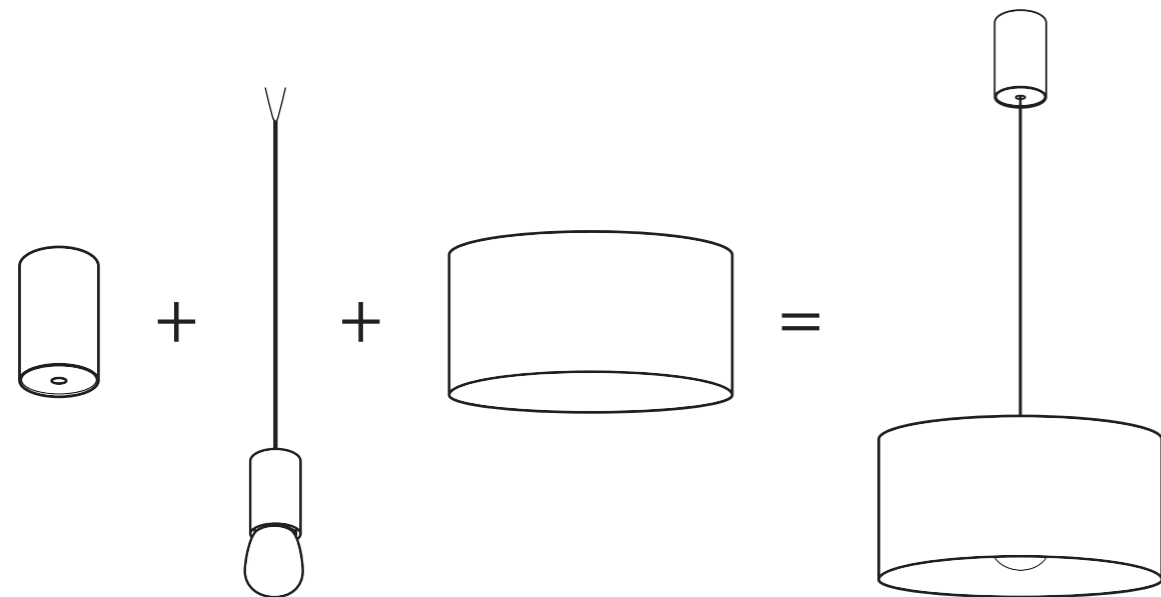

CREATE YOUR OWN LIGHT SYSTEM USING
OUR ELEMENTS

STWÓRZ SWÓJ SYSTEM ŚWIETLNY WYBIERAJĄC NASZE ELEMENTY
СОЗДАЙ СВОЙ СВЕТ, ВЫБИРАЯ НАШИ КОМПОНЕНТЫ

HOW IT WORKS?

JAK TO DZIAŁA?
КАК ЭТО РАБОТАЕТ?

CHOOSE

WYBIERZ
ВЫБРАТЬ

BUY

KUP
КУПИТЬ

ASSEMBLE

ZŁÓŻ
СОБИРАТЬ

SCAN QR CODE TO LEARN HOW IT WORKS

ZESKANUJ KOD QR ABY DOWIEDZIEĆ SIĘ WIĘCEJ
СКАНИРУЙТЕ QR-КОД, ЧТОБЫ УЗНАТЬ, КАК ОНО РАБОТАЕТ



COMPLETE LAMP

KOMPLETNA LAMPA
ЗАВЕРШЕННЫЙ СВЕТИЛЬНИК

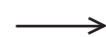
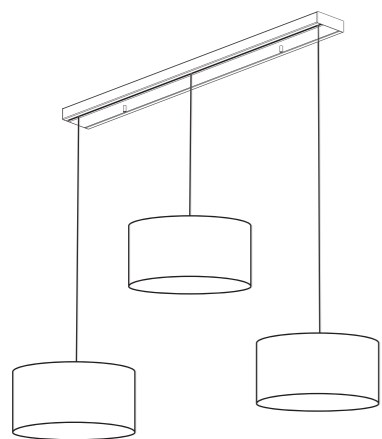

CAMELEON LAMP SHADES

CAMELEON KLOSZE
CAMELEON ПЛАФОНЫ

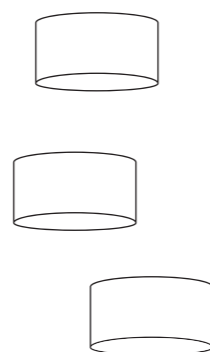

CAMELEON SUSPENSION

CAMELEON ZAWIESZENIE
CAMELEON ПОДВЕС

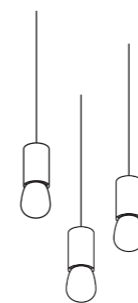

CAMELEON FIXING

CAMELEON AKCESORIA MONTAŻOWE
CAMELEON АКЦЕССУАРЫ ДЛЯ КРЕПЛЕНИЯ

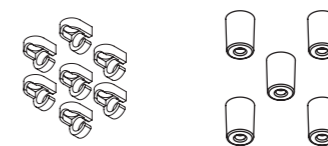
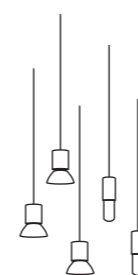
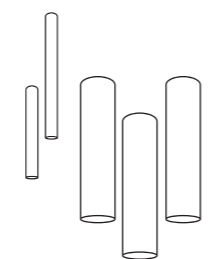
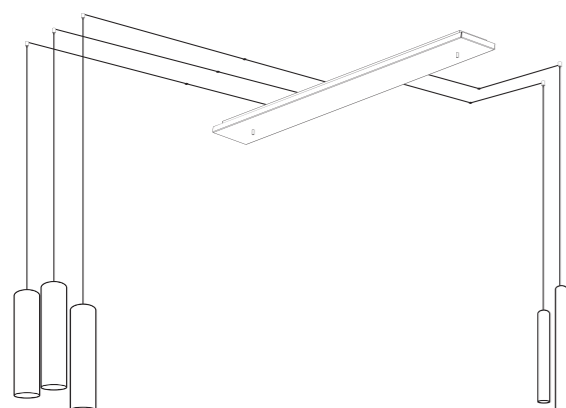
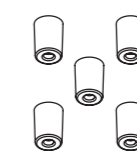
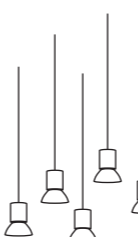
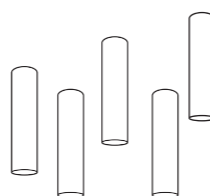
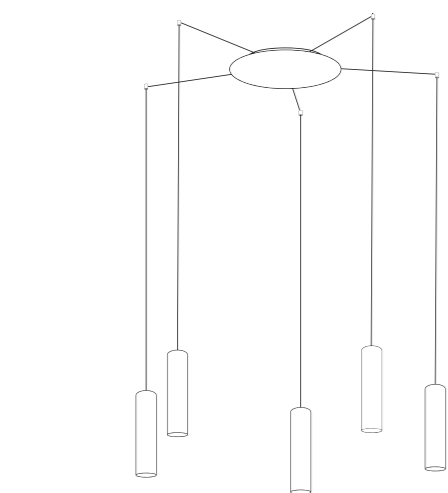
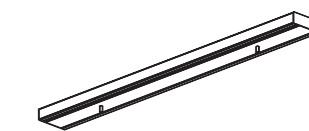

CHOOSE

CHOOSE ELEMENTS TO CREATE PERFECTLY FUNCTIONAL LAMP FOR YOUR HOME

WYBIERZ

WYBIERZ ELEMENTY DO ZŁOŻENIA LAMPY IDEALNIE DOPASOWANEJ DO TWOJEGO DOMU

ВЫБРАТЬ

ВЫБЕРИТЕ ЭЛЕМЕНТЫ ДЛЯ СБОРКИ СВЕТИЛЬНИКА, ИДЕАЛЬНО ПОДОБРОННОГО К ВАШЕМУ ДОМУ

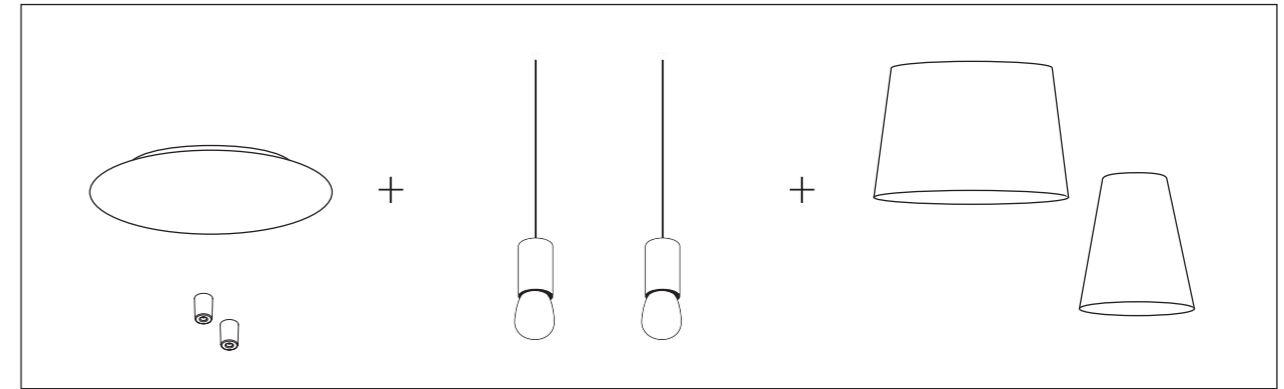

1. CHOOSE ELEMENTS TO CREATE PERFECTLY FUNCTIONAL LAMP FOR YOUR HOME
1. WYBIERZ ELEMENTY DO ZŁOŻENIA LAMPY IDEALNIE DOPASOWANEJ DO TWOJEGO DOMU
1. ВЫБЕРИТЕ ЭЛЕМЕНТЫ ДЛЯ СБОРКИ СВЕТИЛЬНИКА, ИДЕАЛЬНО ПОДОБРОННОГО К ВАШЕМУ ДОМУ

BUY

BUY CORRECT AMOUNT OF:

- CAMELEON
- LAMP SHADES
 - SUSPENSION
 - CANOPY
 - FIXING

KUP

ODPOWIEDNIĄ ILOŚĆ ELEMENTÓW:

- CAMELEON
- KLOSZE
 - ZAWIESZENIE
 - PUSZKA
 - AKCESORIA MONTAŻOWE

КУПИТЬ

ПРАВИЛЬНОЕ КОЛИЧЕСТВО ЭЛЕМЕНТОВ:

- CAMELEON
- ПЛАФОНЫ
 - ПОДВЕС
 - ОСНОВАНИЕ
 - АКССУАРЫ ДЛЯ КРЕПЛЕНИЯ

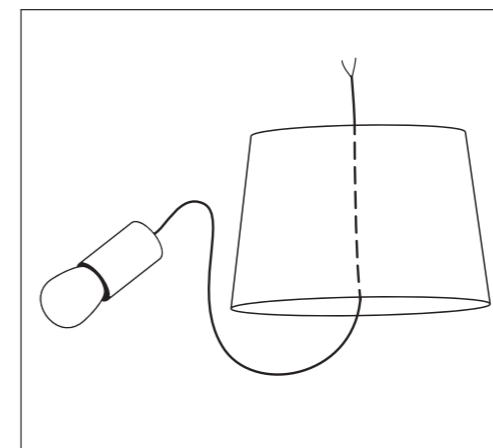

2. PUT THE SUSPENSION THROUGH THE LAMP SHADE
2. PRZEŁÓŻ ZAWIESZENIE PRZEZ KLOSZ
2. ПЕРЕМЕСТИ ПОДВЕС ЧЕРЕЗ ПЛАФОН

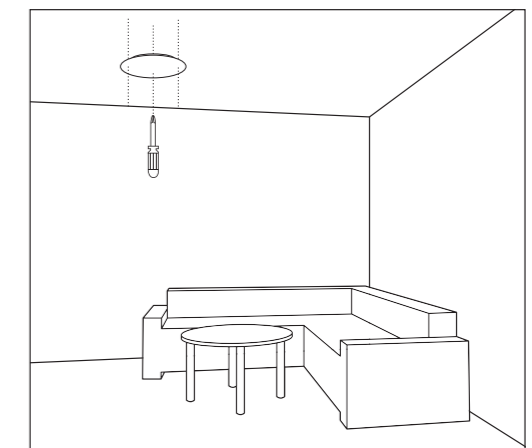

3. FIX THE CAMELEON CANOPY
3. PRZYKRĘĆ PUSZKĘ
3. ПРИВИНТИТЬ ОСНОВАНИЕ

ASSEMBLE

EASY ASSEMBLING ACCORDING TO THE USER'S MANUAL

ZŁÓŻ

ŁATWY MONTAŻ WEDŁUG ZAŁĄCZONEJ INSTRUKCJI

СОБИРАТЬ

ЛЕГКАЯ СБОРКА В СООТВЕТСТВИИ С ПРИЛАГАЕМОЙ ИНСТРУКЦИЕЙ

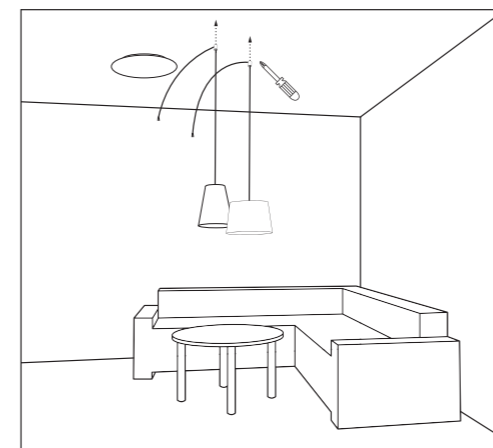

4. FIX THE SUSPENSION
4. ZAMOCUJ ZAWIESZENIE
4. КРЕПИТЬ ПОДВЕС

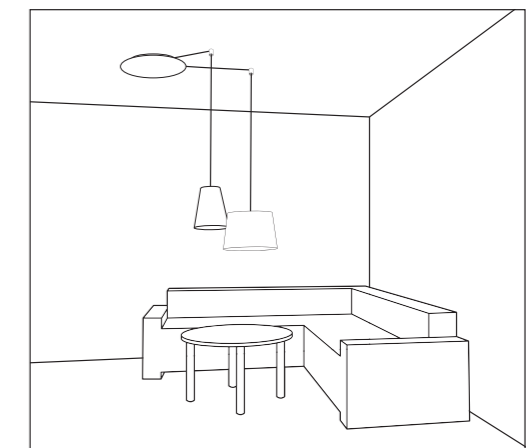

5. CONNECT THE FIXTURES TO THE CAMELEON CANOPY
5. PODŁĄCZ ZAWIESZENIE DO PUSZKI
5. ПОДКЛЮЧИТЬ СВЕТИЛЬНИК К ОСНОВАНИЮ CAMELEON





ELEMENTS INCLUDED / UŻYTE ELEMENTY / ИСПОЛЬЗОВАННЫЕ ЭЛЕМЕНТЫ

	ELEMENT	ITEM NO.	PAGE
1	CANOPY A	8563	69
2	CABLE GU10	8630	68
3	MOUNTING B	8393	73
4	MOUNTING A	8395	73
5	CYLINDER S	8546	38
6	CYLINDER M	8543	38
7	CYLINDER L	8540	38

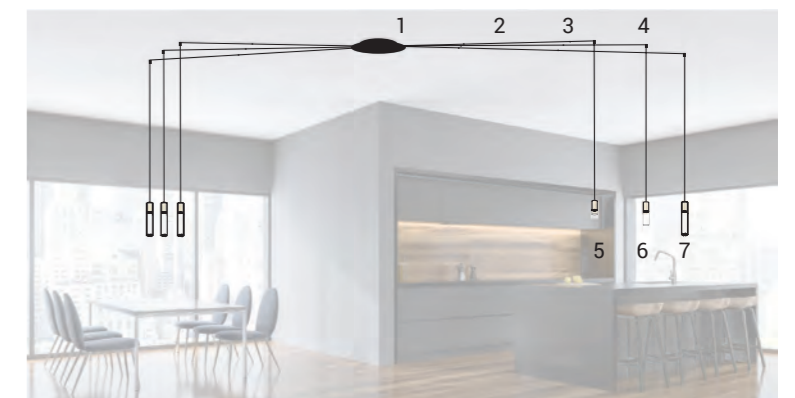



ELEMENTS INCLUDED / UŻYTE ELEMENTY / ИСПОЛЬЗОВАННЫЕ ЭЛЕМЕНТЫ

	ELEMENT	ITEM NO.	PAGE
1	CANOPY B 1500	8608	70
2	CABLE G9	8632	68
3	LASER 490	8572	28





ELEMENTS INCLUDED / UŻYTE ELEMENTY / ИСПОЛЬЗОВАННЫЕ ЭЛЕМЕНТЫ

	ELEMENT	ITEM NO.	PAGE
1	CANOPY B 780	8561	70
2	CANOPY C 780	8556	71
3	CABLE G9	8632	68
4	CABLE E27	8670	68
5	LASER 750	8567	28
6	EGG M	8607	26





ELEMENTS FOR ASSEMBLY

ELEMENTY DO MONTAŻU
МОНТАЖНЫЕ ЭЛЕМЕНТЫ



CAMELEON WAVE L
8600 G

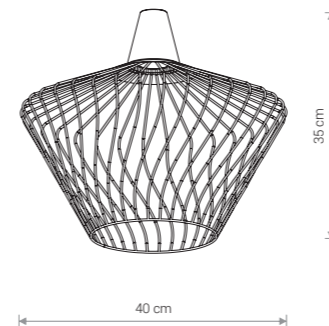

CAMELEON WAVE S

painted steel / stal lakierowana / лакированная сталь

8606 ○ WH 8605 ● BL

works with / zastosuj z / применять с

Ⓟ 1× CAMELEON CABLE E27

Ⓟ 1× CAMELEON CABLE GU10

electroplated brass / stal mosiądzowana / латунная сталь

8604 ● G

works with / zastosuj z / применять с

Ⓟ 1× CAMELEON CABLE E27

Ⓟ 1× CAMELEON CABLE GU10

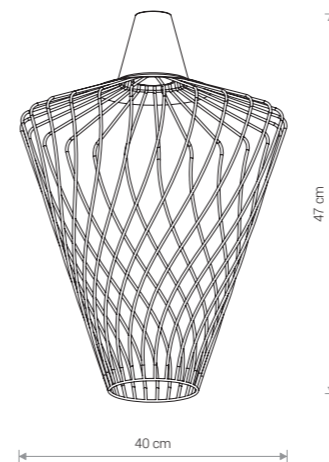

CAMELEON WAVE L

painted steel / stal lakierowana / лакированная сталь

8603 ○ WH 8602 ● BL

works with / zastosuj z / применять с

Ⓟ 1× CAMELEON CABLE E27

Ⓟ 1× CAMELEON CABLE GU10

electroplated brass / stal mosiądzowana / латунная сталь

8600 ● G

works with / zastosuj z / применять с

Ⓟ 1× CAMELEON CABLE E27

Ⓟ 1× CAMELEON CABLE GU10

CAMELEON WAVE S
8606 WH



CAMELEON WAVE S
8604 G



CAMELEON WAVE L
8602 BL





CAMELEON LUKSOR L
8592 G

CAMELEON LUKSOR S
8596 G

CAMELEON LUKSOR L

painted steel / stal lakierowana / лакированная сталь

8593 ● BL

works with / zastosuj z / применять с

Ⓛ 1× CAMELEON CABLE E27

electroplated brass / stal mosiądzowana / латунная сталь

8592 ● G

works with / zastosuj z / применять с

Ⓛ 1× CAMELEON CABLE E27

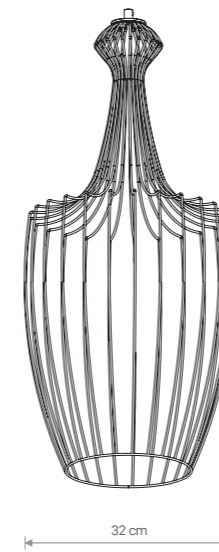

72 cm

32 cm

CAMELEON LUKSOR L
8593 BL



CAMELEON LUKSOR S
8597 BL

CAMELEON LUKSOR S

painted steel / stal lakierowana / лакированная сталь

8597 ● BL

works with / zastosuj z / применять с

Ⓛ 1× CAMELEON CABLE E27

electroplated brass / stal mosiądzowana / латунная сталь

8596 ● G

works with / zastosuj z / применять с

Ⓛ 1× CAMELEON CABLE E27

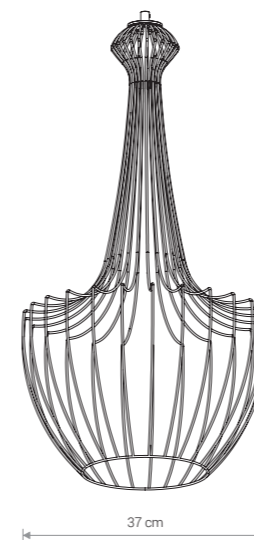

72 cm

37 cm

CAMELEON LUKSOR S
8597 BL



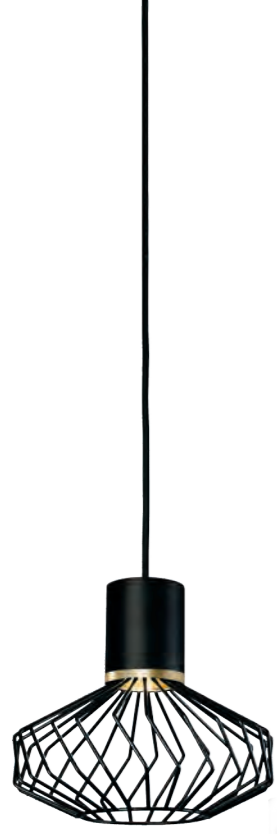

CAMELEON PICO A
8591 BL/G



CAMELEON PICO B
8590 BL/G



CAMELEON PICO C
8588 BL/G



CAMELEON ABI M
8582 BL



CAMELEON ABI S
8586 BL



CAMELEON ABI L
8577 BL

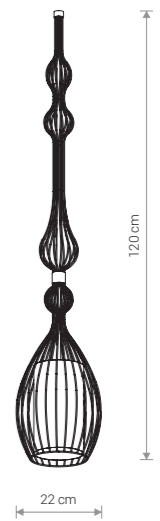
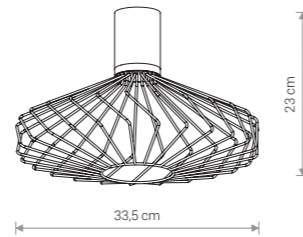
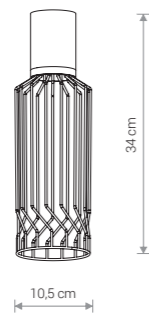
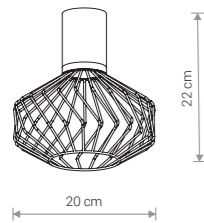

CAMELEON PICO A

painting steel, electroplated brass / stal lakierowana, stal mosiadzowana / лакированная сталь, латунная сталь

8591 ● BL/G

works with / zastosuj z / применять с

Ⓢ 1× CAMELEON CABLE GU10

CAMELEON PICO B

painting steel, electroplated brass / stal lakierowana, stal mosiadzowana / лакированная сталь, латунная сталь

8590 ● BL/G

works with / zastosuj z / применять с

Ⓢ 1× CAMELEON CABLE GU10

CAMELEON PICO C

painting steel, electroplated brass / stal lakierowana, stal mosiadzowana / лакированная сталь, латунная сталь

8588 ● BL/G

works with / zastosuj z / применять с

Ⓢ 1× CAMELEON CABLE GU10

CAMELEON ABI M

painting steel, shade / stal lakierowana, abażur / лакированная сталь, абажур

8584 ○ WH 8582 ● BL

works with / zastosuj z / применять с

Ⓢ 1× CAMELEON CABLE E27

CAMELEON ABI S

painting steel, shade / stal lakierowana, abażur / лакированная сталь, абажур

8587 ○ WH 8586 ● BL

works with / zastosuj z / применять с

Ⓢ 1× CAMELEON CABLE E27

CAMELEON ABI L

painting steel, shade / stal lakierowana, abażur / лакированная сталь, абажур

8581 ○ WH 8577 ● BL

works with / zastosuj z / применять с

Ⓢ 1× CAMELEON CABLE E27

CAMELEON
CANOPY F
8547 BL



CAMELEON UMBRELLA
8575 G



CAMELEON UMBRELLA
8574 BL

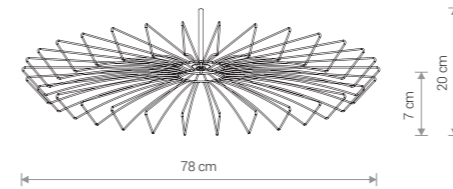

CAMELEON UMBRELLA

electroplated brass / stal mosiądzowana /
латунная сталь

8575  G

works with / zastosuj z / применять с

 1× CAMELEON CABLE E27

painted steel / stal lakierowana /
лакированная сталь

8574  BL

works with / zastosuj z / применять с

 1× CAMELEON CABLE E27



CAMELEON GSTAR
8576 G/BL

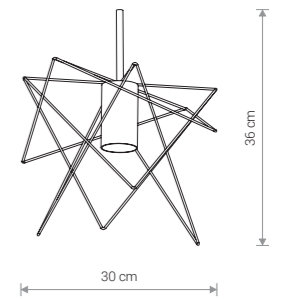

CAMELEON GSTAR

electroplated brass, painted steel /
stal mosiądzowana, stal lakierowana /
латунная сталь, лакированная сталь

8576  G/BL

works with / zastosuj z / применять с

 1× CAMELEON CABLE GU10



CAMELEON EGG M
8607 BL/G

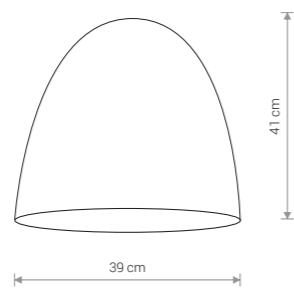

CAMELEON EGG M

composite / kompozyt / композитный

8607  BL/G

works with / zastosuj z / применять с

 1x CAMELEON CABLE E27



**CAMELEON
CANOPY B 780**
8561 BL

CAMELEON EGG M
8607 BL/G



CAMELEON LASER 490

painted steel / stal lakierowana / лакированная сталь

8573 ○ WH 8572 ● BL

works with / zastosuj z / применять с

Ⓛ 1× CAMELEON CABLE G9

brass / mosiądz / латунь

8571 ● BS

works with / zastosuj z / применять с

Ⓛ 1× CAMELEON CABLE G9



CAMELEON LASER 490
8573 WH

CAMELEON LASER 750
8568 BL

CAMELEON LASER 1000
8486 BS

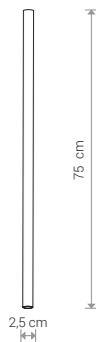

CAMELEON LASER 750

painted steel / stal lakierowana / лакированная сталь

8570 ○ WH 8568 ● BL

works with / zastosuj z / применять с

Ⓛ 1× CAMELEON CABLE G9

brass / mosiądz / латунь

8567 ● BS

works with / zastosuj z / применять с

Ⓛ 1× CAMELEON CABLE G9



CAMELEON LASER 1000

painted steel / stal lakierowana / лакированная сталь

8488 ○ WH 8487 ● BL

works with / zastosuj z / применять с

Ⓛ 1× CAMELEON CABLE G9

brass / mosiądz / латунь

8486 ● BS

works with / zastosuj z / применять с

Ⓛ 1× CAMELEON CABLE G9



CAMELEON CANOPY C 780
8556 BL

CAMELEON LASER 750
8567 BS



CAMELEON EYE L
8484 BS



CAMELEON EYE M
8485 BS

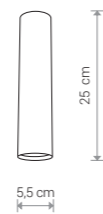

CAMELEON EYE M

brass / mosiądz / латунь

8485 ● BS

works with / zastosuj z / применять с

Ⓛ 1× CAMELEON CABLE GU10

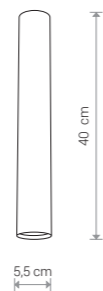

CAMELEON EYE L

brass / mosiądz / латунь

8484 ● BS

works with / zastosuj z / применять с

Ⓛ 1× CAMELEON CABLE GU10

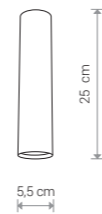

CAMELEON EYE M

painted steel / stal lakierowana /
лакированная сталь

8483 ○ WH 8478 ○ SI

8476 ● GR 8481 ● BL

works with / zastosuj z / применять с

Ⓛ 1× CAMELEON CABLE GU10

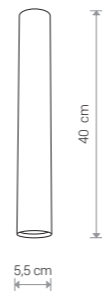

CAMELEON EYE L

painted steel / stal lakierowana /
лакированная сталь

8482 ○ WH 8477 ○ SI

8475 ● GR 8480 ● BL

works with / zastosuj z / применять с

Ⓛ 1× CAMELEON CABLE GU10



CAMELEON EYE M
8478 SI



CAMELEON EYE L
8475 GR



CAMELEON EYE L
8482 WH



CAMELEON POLY L
8472 WH



CAMELEON POLY M
8473 BL

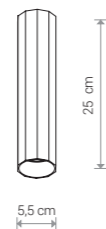

CAMELEON POLY M

painted aluminum / aluminium lakierowane /
лакированный алюминий

8474 ○ WH 8473 ● BL

works with / zastosuj z / применять с

Ⓢ 1× CAMELEON CABLE GU10



CAMELEON POLY L

painted aluminum / aluminium lakierowane /
лакированный алюминий

8472 ○ WH 8471 ● BL

works with / zastosuj z / применять с

Ⓢ 1× CAMELEON CABLE GU10



CAMELEON TULUM
8467 CN



CAMELEON TULUM
8426 CN

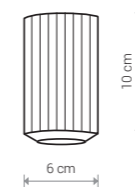

CAMELEON TULUM

concrete / beton / бетон

8467 ● CN

works with / zastosuj z / применять с

Ⓢ 1× CAMELEON CABLE E27

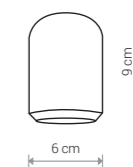

CAMELEON TULUM

concrete / beton / бетон

8426 ● CN

works with / zastosuj z / применять с

Ⓢ 1× CAMELEON CABLE E27



CAMELEON GEOMETRIC C
8465 CN

CAMELEON GEOMETRIC A
8466 CN



CAMELEON GEOMETRIC A
8466 CN



CAMELEON GEOMETRIC B
8425 CN



CAMELEON GEOMETRIC C
8465 CN

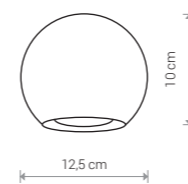

**CAMELEON
GEOMETRIC A**

concrete / beton / бетон

8466 ● CN

works with / zastosuj z / применять с

💡 1× CAMELEON CABLE GU10

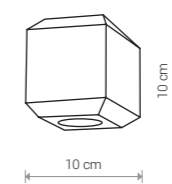

**CAMELEON
GEOMETRIC B**

concrete / beton / бетон

8425 ● CN

works with / zastosuj z / применять с

💡 1× CAMELEON CABLE GU10

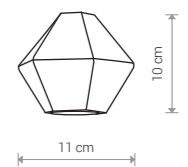

**CAMELEON
GEOMETRIC C**

concrete / beton / бетон

8465 ● CN

works with / zastosuj z / применять с

💡 1× CAMELEON CABLE GU10

CAMELEON
CANOPY G
8360 BL

CAMELEON CYLINDER M
8543 TR/BS

This arrangement was made of elements from **PROFILE TRACK** system that is presented in Nowodvorski Lighting 2019/20 catalogue.

Na aranżacji wykorzystano element systemu **PROFILE TRACK** znajdujący się w ofercie prezentowanej w Katalogu 2019/2020.

В данной визуализации использованы элементы системы **PROFILE TRACK**, которая представлена в каталоге 2019/20.



CAMELEON CYLINDER L
8540 TR/BS

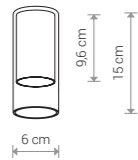

CAMELEON CYLINDER S

glass, painted steel / szkło, stal laskierowana /
стекло, лакированная сталь

8544 ● TR/BL 8545 ○ TR/WH

works with / zastosuj z / применять с

1x CAMELEON CABLE GU10

glass, brass / szkło, mosiądz /
стекло, латунь

8546 ● TR/BS

works with / zastosuj z / применять с

1x CAMELEON CABLE GU10



CAMELEON CYLINDER S
8544 TR/BL

CAMELEON CYLINDER M
8542 TR/WH

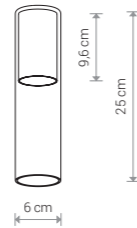

CAMELEON CYLINDER M

glass, painted steel / szkło, stal laskierowana /
стекло, лакированная сталь

8541 ● TR/BL 8542 ○ TR/WH

works with / zastosuj z / применять с

1x CAMELEON CABLE GU10

glass, brass / szkło, mosiądz /
стекло, латунь

8543 ● TR/BS

works with / zastosuj z / применять с

1x CAMELEON CABLE GU10

1 x GU10 not included

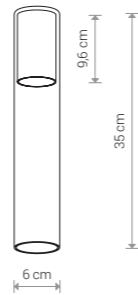

CAMELEON CYLINDER L

glass, painted steel / szkło, stal laskierowana /
стекло, лакированная сталь

8537 ● TR/BL 8538 ○ TR/WH

works with / zastosuj z / применять с

1x CAMELEON CABLE GU10

glass, brass / szkło, mosiądz /
стекло, латунь

8540 ● TR/BS

works with / zastosuj z / применять с

1x CAMELEON CABLE GU10

1 x G9 not included

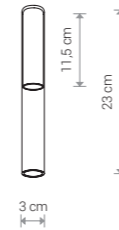

CAMELEON STRAW S

glass, painted steel / szkło, stal laskierowana /
стекло, лакированная сталь

8400 ● TR/BL 8536 ○ TR/WH

works with / zastosuj z / применять с

1x CAMELEON CABLE G9

glass, brass / szkło, mosiądz /
стекло, латунь

8401 ● TR/BS

works with / zastosuj z / применять с

1x CAMELEON CABLE G9

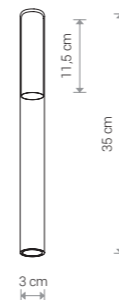

CAMELEON STRAW M

glass, painted steel / szkło, stal laskierowana /
стекло, лакированная сталь

8402 ● TR/BL 8535 ○ TR/WH

works with / zastosuj z / применять с

1x CAMELEON CABLE G9

glass, brass / szkło, mosiądz /
стекло, латунь

8403 ● TR/BS

works with / zastosuj z / применять с

1x CAMELEON CABLE G9



CAMELEON STRAW S
8536 TR/WH

CAMELEON STRAW M
8402 TR/BL





CAMELEON PEAR L
8532 TR/G

CAMELEON PEAR M
8533 TR/G

CAMELEON PEAR S
8534 TR/G

**CAMELEON
CANOPY A**
8563 BL

**CAMELEON
CABLE WITH
SWITCH**
8611 BL



CAMELEON PEAR S
8534 TR/G

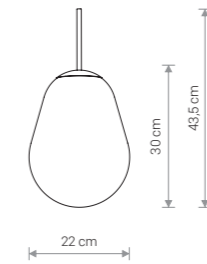

CAMELEON PEAR S

glass, electroplated brass / szkło, stal mosiądzowana /
стекло, латунная сталь

8534 TR/G

works with / zastosuj z / применять с

1× CAMELEON CABLE E27

1× CAMELEON CABLE G9



CAMELEON PEAR M
8533 TR/G

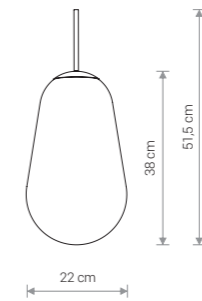

CAMELEON PEAR M

glass, electroplated brass / szkło, stal mosiądzowana /
стекло, латунная сталь

8533 TR/G

works with / zastosuj z / применять с

1× CAMELEON CABLE E27

1× CAMELEON CABLE G9



CAMELEON PEAR L
8532 TR/G

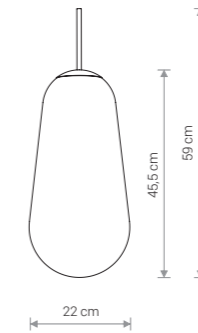

CAMELEON PEAR L

glass, electroplated brass / szkło, stal mosiądzowana /
стекло, латунная сталь

8532 TR/G

works with / zastosuj z / применять с

1× CAMELEON CABLE E27

1× CAMELEON CABLE G9



CAMELEON SPHERE S
8531 TR



CAMELEON SPHERE M
8530 TR



CAMELEON SPHERE L
8528 TR



CAMELEON SPHERE XL
8527 TR

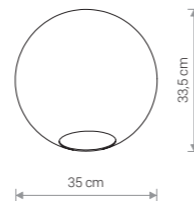
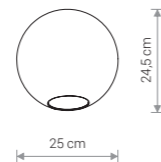
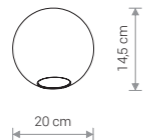
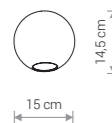

CAMELEON SPHERE S

glass / szkło / стекло

8531 ○ TR

works with / zastosuj z / применять с

Ⓢ 1× CAMELEON CABLE G9

CAMELEON SPHERE M

glass / szkło / стекло

8530 ○ TR

works with / zastosuj z / применять с

Ⓢ 1× CAMELEON CABLE E27

Ⓢ 1× CAMELEON CABLE G9

CAMELEON SPHERE L

glass / szkło / стекло

8528 ○ TR

works with / zastosuj z / применять с

Ⓢ 1× CAMELEON CABLE E27

Ⓢ 1× CAMELEON CABLE G9

CAMELEON SPHERE XL

glass / szkło / стекло

8527 ○ TR

works with / zastosuj z / применять с

Ⓢ 1× CAMELEON CABLE E27

Ⓢ 1× CAMELEON CABLE G9

CAMELEON SPHERE XL
8527 TR

CAMELEON SPHERE L
8528 TR

CAMELEON SPHERE M
8530 TR

CAMELEON SPHERE S
8531 TR





CAMELEON BIO S
8458 NT

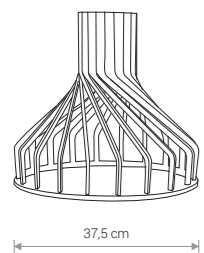

**CAMELEON
BIO S**

plywood / sklejka / дерево

8458 ● NT 8457 ○ WH

works with / zastosuj z / применять с

Ⓛ 1× CAMELEON CABLE E27

Ⓛ 1× CAMELEON CABLE GU10

CAMELEON BIO M
8461 WH

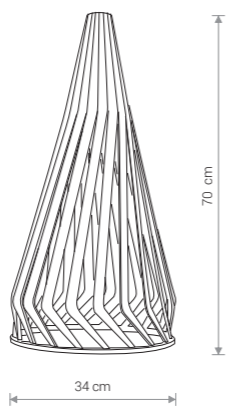

**CAMELEON
BIO M**

plywood / sklejka / дерево

8462 ● NT 8461 ○ WH

works with / zastosuj z / применять с

Ⓛ 1× CAMELEON CABLE E27

Ⓛ 1× CAMELEON CABLE GU10



**CAMELEON
CANOPY B 1500**
8560 WH

CAMELEON DOVER
8464 NT

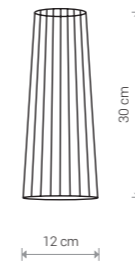

**CAMELEON
DOVER**

plywood / sklejka / дерево

8464 ● NT 8463 ● BL

works with / zastosuj z / применять с

Ⓛ 1× CAMELEON CABLE GU10



CAMELEON DOVER
8463 BL

CAMELEON DOVER
8464 NT



CAMELEON WHEEL
8424 G

CAMELEON WHEEL
8423 BL

CAMELEON WHEEL
8423 BL

CAMELEON WHEEL
8424 G

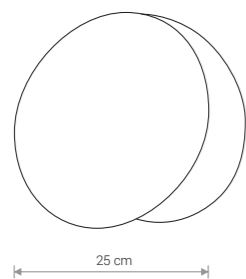

25 cm

CAMELEON WHEEL

plywood, painted steel / sklejka, stal lakierowana /
drewno, lakierowana stal

8424 ● G 8423 ● BL

works with / zastosuj z / применять с

Ⓢ 1× CAMELEON CABLE E27



CAMELEON CANOPY B 1500
8558 BL

CAMELEON CONE M
8411 BL/G





CAMELEON CONE M
8497 V NB/G



CAMELEON CONE M
8411 BL/G



CAMELEON CONE M
8414 V GN/G



CAMELEON CONE L
8494 V PI/WH



CAMELEON CONE L
8408 WH



CAMELEON CONE L
8491 V BL

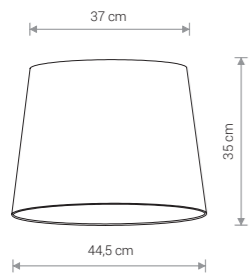

CAMELEON CONE M

shade / abażur / абажур

8498 V PI/WH 8497 V NB/G 8414 V GN/G 8496 V WH 8495 V BL

8412 GY 8411 BL/G 8413 WH

works with / zastosuj z / применять с

1x CAMELEON CABLE E27

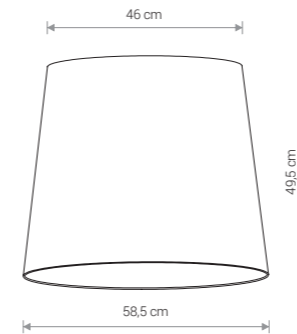

CAMELEON CONE L

shade / abażur / абажур

8494 V PI/WH 8493 V NB/G 8410 V GN/G 8492 V WH 8491 V BL

8407 GY 8406 BL/G 8408 WH

works with / zastosuj z / применять с

1x CAMELEON CABLE E27



CAMELEON CONE S
8502 V PI/WH



CAMELEON CONE S
8503 V GN/G



CAMELEON CONE S
8501 V NB/G



CAMELEON CONE S
8504 BL/G



CAMELEON CONE S
8415 V BL

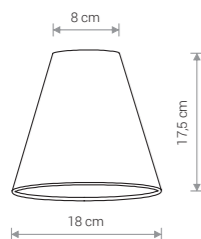

CAMELEON CONE S

shade / abażur / абажур

8502 V PI/WH 8501 V NB/G 8503 V GN/G 8500 V WH 8415 V BL

8505 GY 8504 BL/G 8416 WH

works with / zastosuj z / применять с

1× CAMELEON CABLE E27

1× CAMELEON CABLE GU10

1× CAMELEON CABLE G9



CAMELEON CONE M
8498 V PI/WH

CAMELEON BARREL L
8508 V WH

CAMELEON
CANOPY A
8563 BL

CAMELEON
BARREL WIDE S
8512 V GN/G

CAMELEON
BARREL L
8417 V GN/G





CAMELEON
BARREL WIDE S
8518 WH



CAMELEON
BARREL WIDE S
8517 GY



CAMELEON
BARREL WIDE S
8515 V PI/WH



CAMELEON
BARREL WIDE S
8514 V NB/G



CAMELEON
BARREL THIN S
8520 V GN/G



CAMELEON
BARREL THIN S
8422 V BL



CAMELEON
BARREL THIN S
8522 V NB/G



CAMELEON
BARREL THIN S
8521 V WH

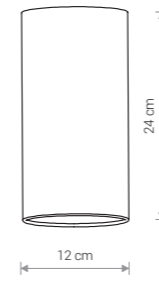
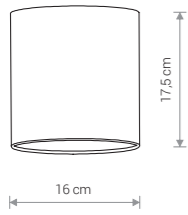

CAMELEON BARREL WIDE S

shade / abażur / абажур

8515 V PI/WH 8514 V NB/G 8512 V GN/G 8513 V WH 8421 V BL

8517 GY 8516 BL/G 8518 WH

works with / zastosuj z / применять с

1× CAMELEON CABLE E27

1× CAMELEON CABLE GU10

1× CAMELEON CABLE G9

CAMELEON BARREL THIN S

shade / abażur / абажур

8523 V PI/WH 8522 V NB/G 8520 V GN/G 8521 V WH 8422 V BL

8525 GY 8524 BL/G 8526 WH

works with / zastosuj z / применять с

1× CAMELEON CABLE E27

1× CAMELEON CABLE GU10

1× CAMELEON CABLE G9



**CAMELEON
CANOPY A**
8563 BL

CAMELEON BARREL L
8420 GY

**CAMELEON
BARREL THIN S**
8526 WH

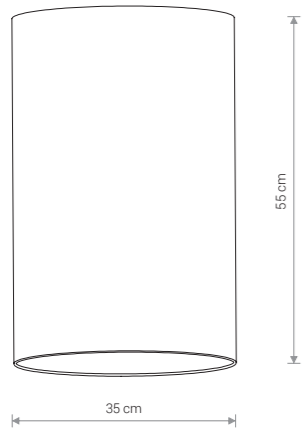

**CAMELEON
BARREL L**

shade / abažur / абажур

8511 V PI/WH 8510 V NB/G 8417 V GN/G 8508 V WH 8507 V BL

8420 GY 8418 BL/G 8506 WH

works with / zastosuj z / применять с

1x CAMELEON CABLE E27



CAMELEON BARREL L
8506 WH

CAMELEON BARREL L
8420 GY

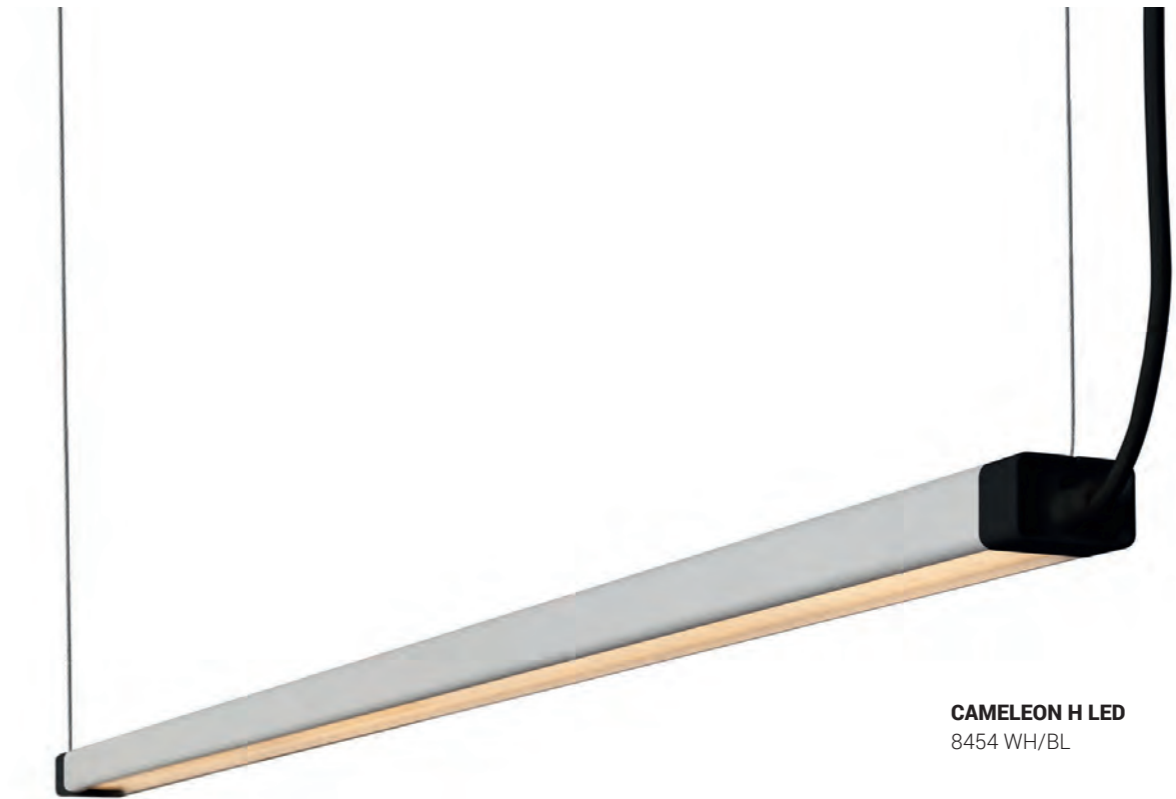

CAMELEON H LED
8454 WH/BL

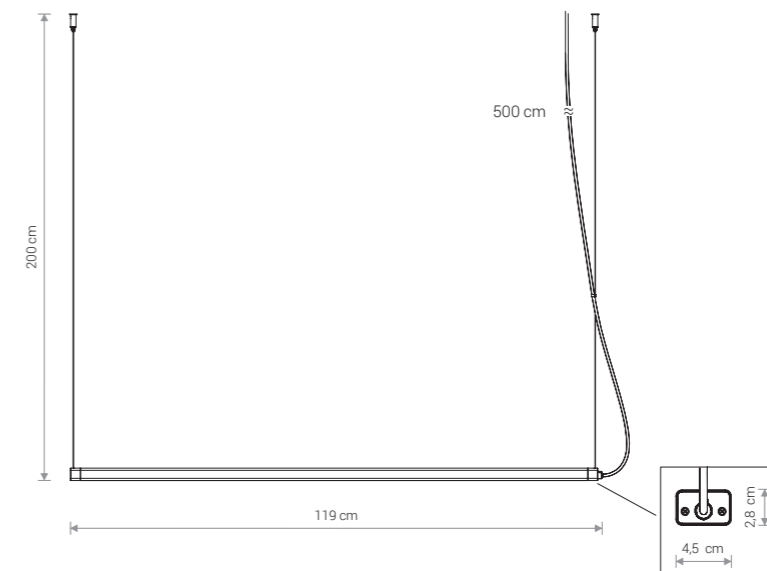

CAMELEON H LED

painted aluminium, PMMA /
aluminium lakierowane, PMMA /
лакированный алюминий, PMMA

8455 ○ WH 8454 ● WH/BL

Ⓛ 36W LED

works with / zastosuj z / применять с

A (8566 WH, 8564 BL), B (8610 WH, 8608 BL)
E (8551 WH, 8550 BL), F (8548 WH, 8547 BL)

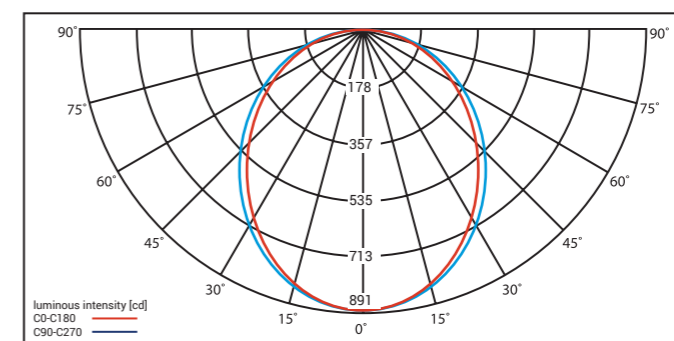

Item No.	INPUT POWER	COLOUR TEMP.	LUMINOUS FLUX	LUMINAIRE EFFICIENCY	COLOUR RENDERING INDEX (CRI ≥)	INPUT	LIFETIME
8455, 8454	36 W LED	3000K	2300 lm	65 lm/W	80	~230V, 50Hz	50 000 h

CAMELEON
CANOPY A
8566 WH

CAMELEON Q LED
8453 WH





CAMELEON A LED
8451 WH

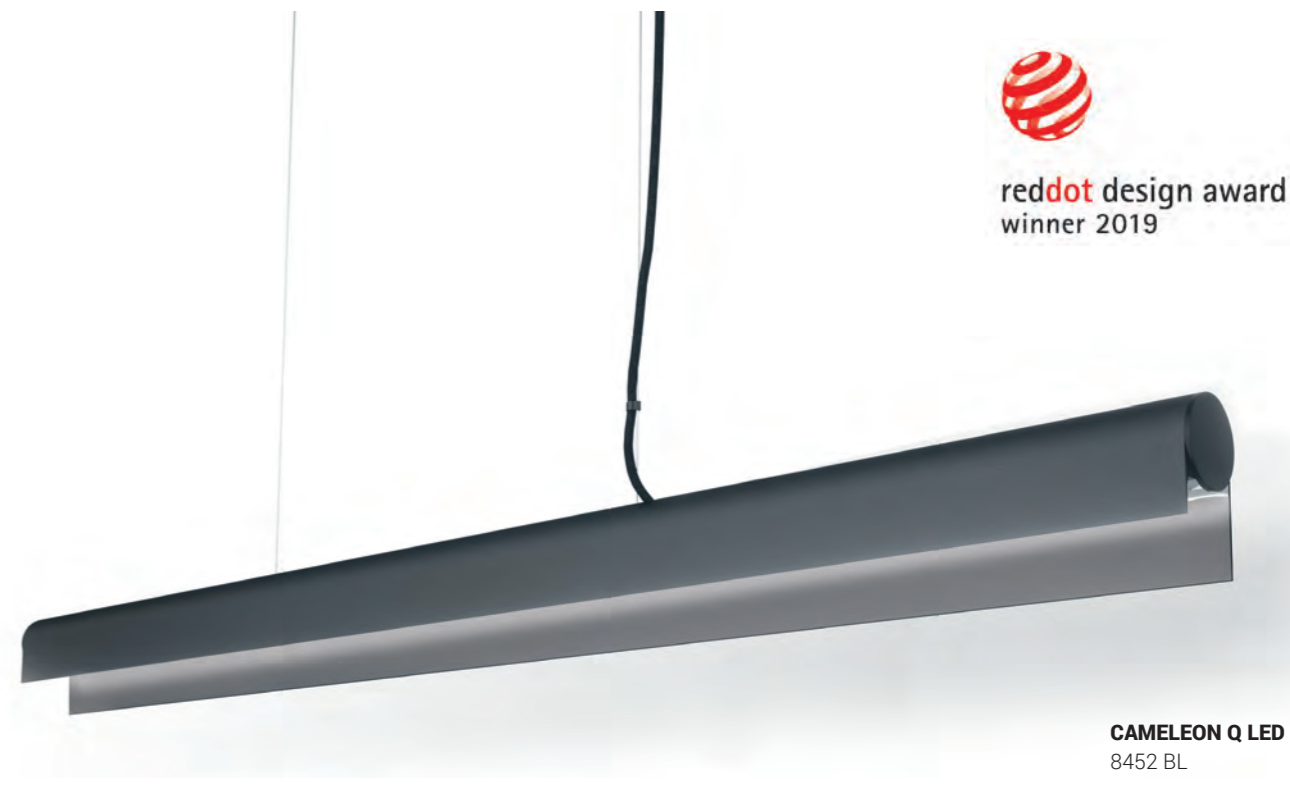

CAMELEON Q LED
8452 BL

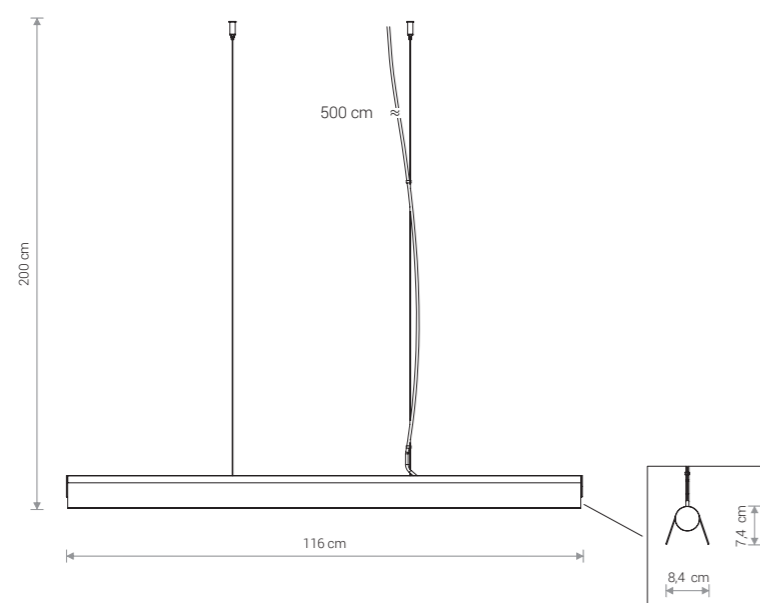

CAMELEON A LED

painted aluminium, PMMA /
aluminium lakierowane, PMMA /
лакированный алюминий, PMMA

8451 ○ WH 8450 ● BL

36W LED

works with / zastosuj z / применять с

A (8566 WH, 8564 BL), B (8610 WH, 8608 BL)
E (8551 WH, 8550 BL), F (8548 WH, 8547 BL)

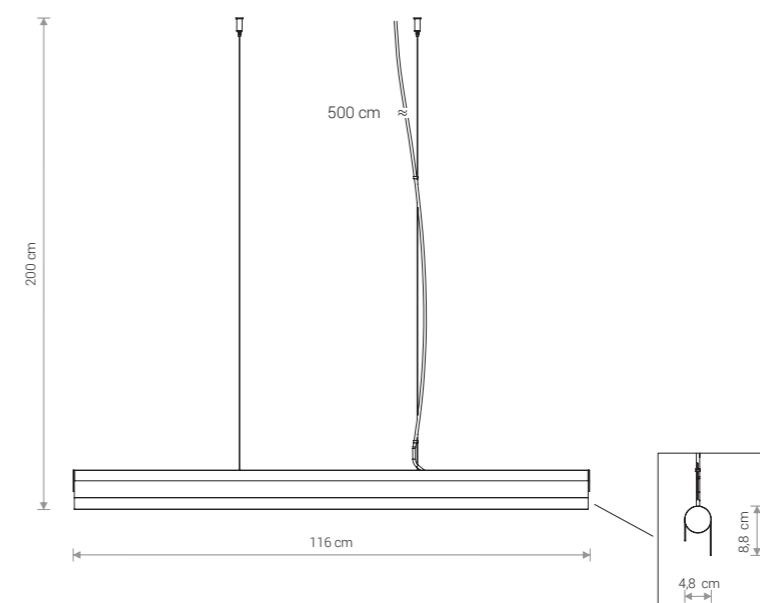

CAMELEON Q LED

painted aluminium, PMMA /
aluminium lakierowane, PMMA /
лакированный алюминий, PMMA

8453 ○ WH 8452 ● BL

36W LED

works with / zastosuj z / применять с

A (8566 WH, 8564 BL), B (8610 WH, 8608 BL)
E (8551 WH, 8550 BL), F (8548 WH, 8547 BL)

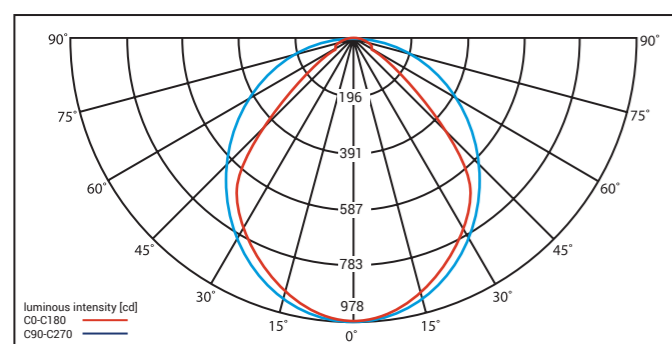

Beam cone diagram - 8451 WH

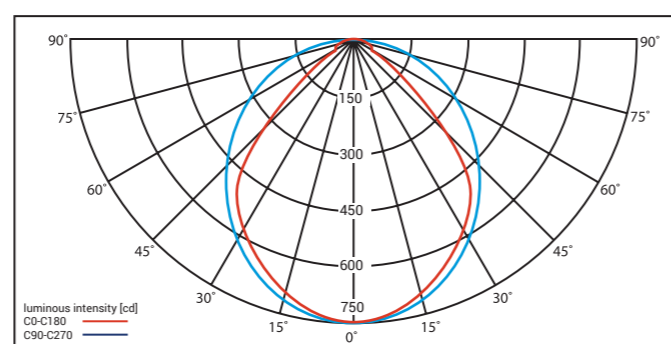

Beam cone diagram - 8450 BL

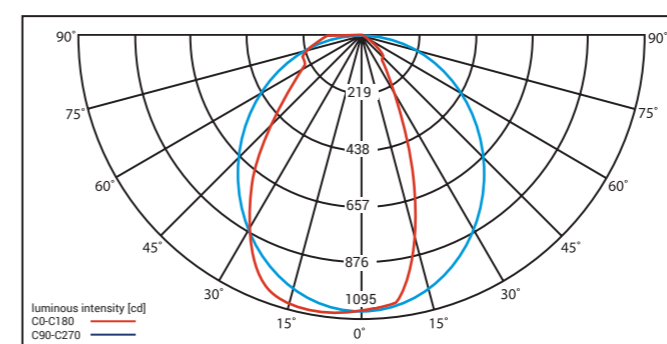

Beam cone diagram - 8453 WH

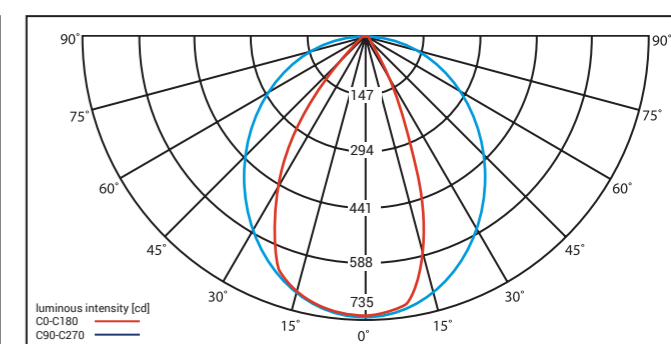

Beam cone diagram - 8452 BL

Item No.	INPUT POWER	COLOUR TEMP.	LUMINOUS FLUX	LUMINAIRE EFFICIENCY	COLOUR RENDERING INDEX (CRI ≥)	INPUT	LIFETIME
8451	36 W LED	3000K	2200 lm	60 lm/W	80	~230V, 50Hz	50 000 h
8450	36 W LED	3000K	1500 lm	40 lm/W	80	~230V, 50Hz	50 000 h

Item No.	INPUT POWER	COLOUR TEMP.	LUMINOUS FLUX	LUMINAIRE EFFICIENCY	COLOUR RENDERING INDEX (CRI ≥)	INPUT	LIFETIME
8453	36 W LED	3000K	2100 lm	60 lm/W	80	~230V, 50Hz	50 000 h
8452	36 W LED	3000K	1100 lm	30 lm/W	80	~230V, 50Hz	50 000 h

CAMELEON CABLE E27 | max 40W

silicone, steel / silikon, stal /
силикон, сталь



● BL

LENGHT	ITEM NO.
1,5 m	8670
2,5 m	8667
3,5 m	8668
5 m	8664
7 m	8663

silicone, steel / silikon, stal /
силикон, сталь



○ WH

LENGHT	ITEM NO.
1,5 m	8654
2,5 m	8652
3,5 m	8653
5 m	8648
7 m	8647

silicone, steel / silikon, stal /
силикон, сталь



● BL/BS

LENGHT	ITEM NO.
1,5 m	8666
2,5 m	8665
3,5 m	8662
5 m	8661
7 m	8660

silicone, steel / silikon, stal /
силикон, сталь



● BL/CH

LENGHT	ITEM NO.
1,5 m	8658
2,5 m	8657
3,5 m	8656
5 m	8655
7 m	8651

silicone, steel / silikon, stal /
силикон, сталь



○ WH/CH

LENGHT	ITEM NO.
1,5 m	8650
2,5 m	8646
3,5 m	8645
5 m	8644
7 m	8643

CAMELEON CABLE G9 | max 10W only LED

silicone, steel / silikon, stal /
силикон, сталь



● BL

LENGHT	ITEM NO.
1,5 m	8632
2,5 m	8631
3,5 m	8627
5 m	8626
7 m	8625

silicone, steel / silikon, stal /
силикон, сталь



○ WH

LENGHT	ITEM NO.
1,5 m	8640
2,5 m	8638
3,5 m	8637
5 m	8636
7 m	8634

silicone, steel / silikon, stal /
силикон, сталь



● BL/BS

LENGHT	ITEM NO.
1,5 m	8622
2,5 m	8621
3,5 m	8618
5 m	8616
7 m	8615

silicone, steel / silikon, stal /
силикон, сталь



● BL/CH

LENGHT	ITEM NO.
1,5 m	8601
2,5 m	8598
3,5 m	8623
5 m	8595
7 m	8594

silicone, steel / silikon, stal /
силикон, сталь



○ WH/CH

LENGHT	ITEM NO.
1,5 m	8585
2,5 m	8583
3,5 m	8624
5 m	8580
7 m	8578

CAMELEON CABLE GU10 | max 10W only LED

silicone, steel / silikon, stal /
силикон, сталь



● BL/CH

LENGHT	ITEM NO.
1,5 m	8635
2,5 m	8633
3,5 m	8641
5 m	8630
7 m	8628

silicone, steel / silikon, stal /
силикон, сталь



○ WH/CH

LENGHT	ITEM NO.
1,5 m	8620
2,5 m	8617
3,5 m	8642
5 m	8614
7 m	8613

CAMELEON CABLE WITH SWITCH

silicone, plastic / silikon, plastik /
силикон, пластики



8611 ● BL 8612 ○ WH

LENGHT	ITEM NO.
1,5 m	8611
1,5 m	8612

works with CANOPY A /
zastosuj z PUSZKA A /
применять с ОСНОВАНИЕ A

8565 ● BL 8563 ○ WH

CAMELEON CANOPY

CAMELEON PUSZKA

CAMELEON ОСНОВАНИЕ

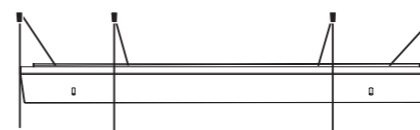
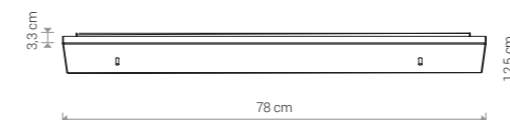
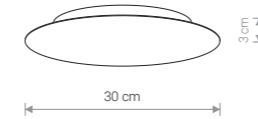

CANOPY A

painted steel, plastic / stal lakierowana, tworzywo sztuczne /
лакированная сталь, пластик

works with / zastosuj z / применять с

Ⓧ max 8 lamps × max 40W

8566 ○ WH 8564 ● BL

works with / zastosuj z / применять с

Ⓧ max 12 lamps × max 40W

8565 ○ WH 8563 ● BL

application: wall / ceiling
zastosowanie: ściana / sufit
применение: стена / потолок

CANOPY D 780

painted steel / stal lakierowana /
лакированная сталь

works with / zastosuj z / применять с

Ⓧ max 12 lamps × max 40W

8552 ● BL 8553 ○ WH

application: wall / ceiling
zastosowanie: ściana / sufit
применение: стена / потолок

CAMELEON CANOPY

CAMELEON PUSZKA
CAMELEON OCHOWANIE

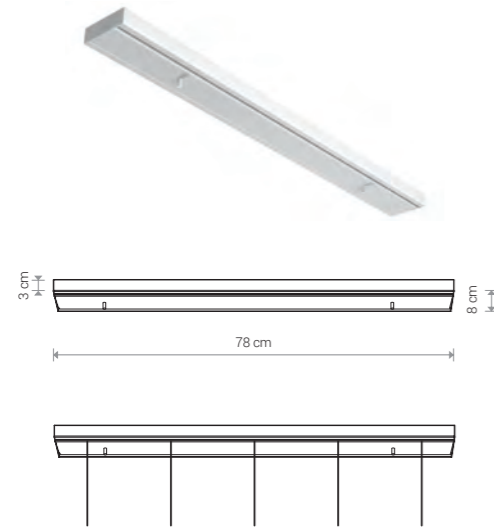

CANOPY B 780

painted steel / stal lakierowana /
лакированная сталь

works with / zastosuj z / применять с

Ⓢ max 12 lamps × max 40W □
8562 ○ WH 8561 ● BL

application: ceiling
zastosowanie: sufit
применение: потолок



CANOPY B 1500

painted steel / stal lakierowana /
лакированная сталь

works with / zastosuj z / применять с

Ⓢ max 8 lamps × max 40W ⊕ □
8610 ○ WH 8608 ● BL

works with / zastosuj z / применять с

Ⓢ max 12 lamps × max 40W □
8560 ○ WH 8558 ● BL

application: ceiling
zastosowanie: sufit
применение: потолок

CAMELEON CANOPY

CAMELEON PUSZKA
CAMELEON OCHOWANIE

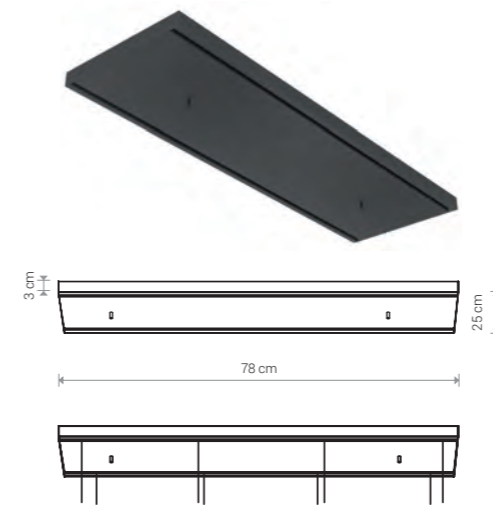

CANOPY C 780

painted steel / stal lakierowana /
лакированная сталь

works with / zastosuj z / применять с

Ⓢ max 12 lamps × max 40W □
8556 ● BL 8557 ○ WH

application: ceiling
zastosowanie: sufit
применение: потолок



CANOPY C 1200

painted steel / stal lakierowana /
лакированная сталь

works with / zastosuj z / применять с

Ⓢ max 12 lamps × max 40W □
8554 ● BL 8555 ○ WH

application: ceiling
zastosowanie: sufit
применение: потолок

CAMELEON CANOPY

CAMELEON PUSZKA
CAMELEON ОСНОВАНИЕ

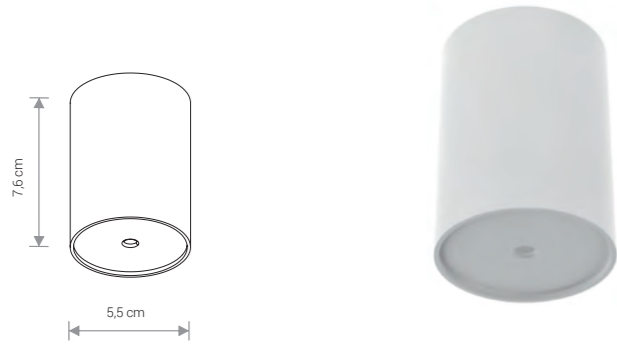

CANOPY E

painting steel / stal lakierowana /
лакированная сталь

works with / zastosuj z / применять с

max 1 lamp × max 40W
8551 WH 8550 BL

application: ceiling
zastosowanie: sufit
применение: потолок

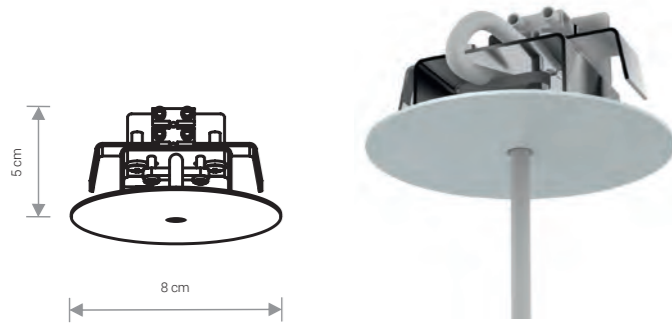

CANOPY F

painting steel / stal lakierowana /
лакированная сталь

works with / zastosuj z / применять с

max 1 lamp × max 40W
8548 WH 8547 BL

application: ceiling
zastosowanie: sufit
приложение: потолок



CANOPY G

plastic / tworzywo sztuczne / пластик

works with / zastosuj z / применять с

max 1 lamp × max 40W
8361 WH 8360 BL

application: ceiling
zastosowanie: sufit
приложение: потолок

works with / zastosuj z / применять с

PROFILE TRACK system (Catalogue 2019/2020) /
PROFILE TRACK system (Katalog 2019/2020) /
система PROFILE TRACK (Каталог 2019/2020)

CAMELEON FIXING

CAMELEON AKCESORIA MONTAŻOWE
CAMELEON АКССЕСУАРЫ ДЛЯ КРЕПЛЕНИЯ

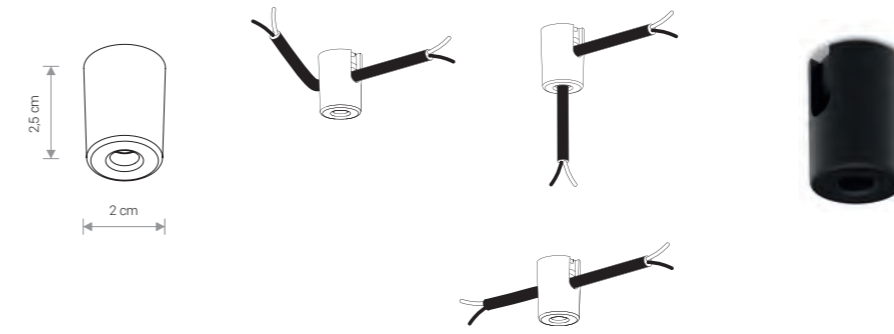

CAMELEON MOUNTING A

CAMELEON MOUNTING A - included (3pcs). Mounting screws are not included /
Zestaw zawiera 3 sztuki elementu CAMELEON MOUNTING A. Zestaw nie zawiera wkrętów montażowych /
CAMELEON MOUNTING A - включено (3 шт.). Монтажные винты не включены

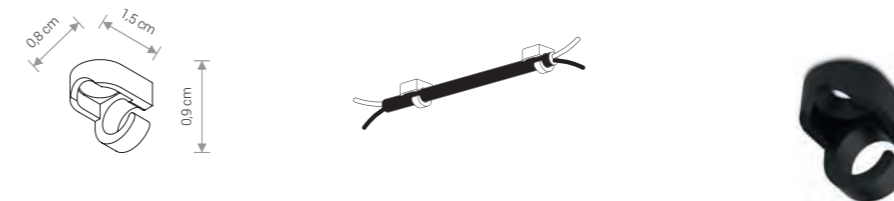

CAMELEON MOUNTING B

CAMELEON MOUNTING B included (5pcs). Mounting screws are included (5pcs) /
Zestaw zawiera 5 sztuk elementu CAMELEON MOUNTING B. Zestaw zawiera 5 sztuk wkrętów montażowych /
CAMELEON MOUNTING B - включено (5 шт.). Монтажные винты включены (5 шт.)

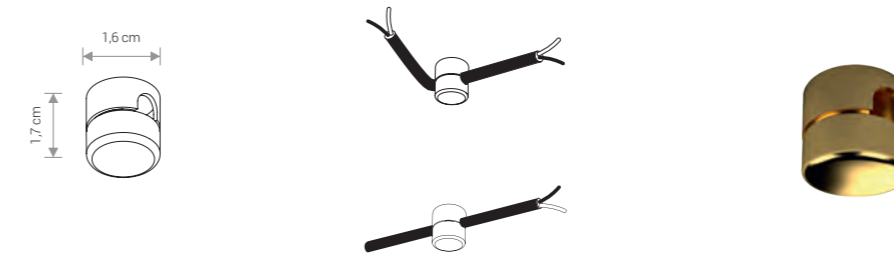

CAMELEON MOUNTING C

CAMELEON MOUNTING C - included (5pcs). Mounting screws - not included /
Zestaw zawiera 5 sztuk elementu CAMELEON MOUNTING C. Zestaw nie zawiera wkrętów montażowych /
CAMELEON MOUNTING C - включено (5 шт.). Монтажные винты не включены

CAMELEON MOUNTING A

plastic / tworzywo sztuczne / пластик

8395 BL 8396 WH

application: wall / ceiling
zastosowanie: ściana / sufit
применение: стена / потолок

allows the change of wire direction
umożliwia zmianę kierunku przebiegu przewodu
позволяет менять направления кабеля

CAMELEON MOUNTING B

plastic / tworzywo sztuczne / пластик

8393 BL 8394 WH

application: wall / ceiling
zastosowanie: ściana / sufit
применение: стена / потолок

prevents wire from sagging
zapobiega obwisaniu przewodu
предотвращает провисание кабеля

CAMELEON MOUNTING C







brass / miedź / латунь

8405 BS

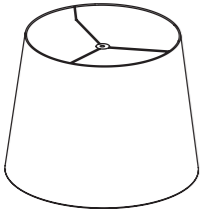
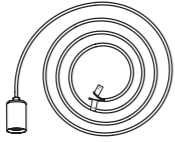
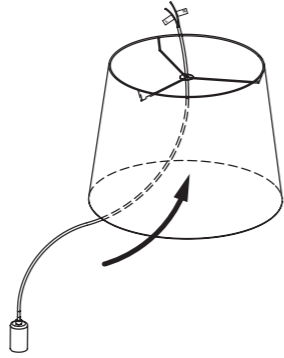
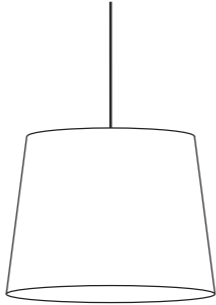
application: wall / ceiling
zastosowanie: ściana / sufit
применение: стена / потолок

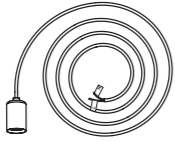
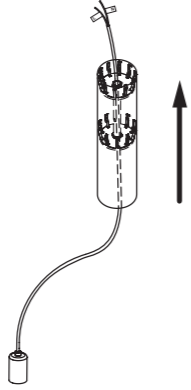
prevents wire from sagging
zapobiega obwisaniu przewodu
предотвращает провисание кабеля

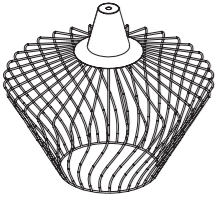
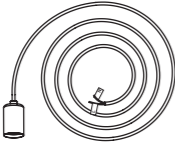
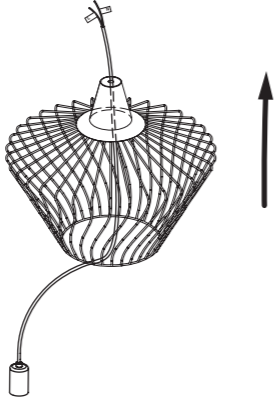
CAMELEON MANUALS

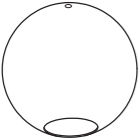
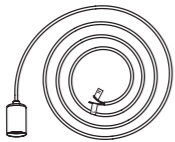
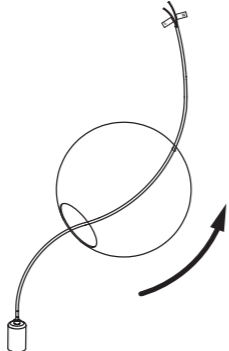
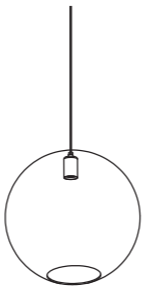
LAMP SHADE	SUSPENSION	SUSPENSION + LAMP SHADE	READY FOR INSTALLATION
KLOSZ АБАЖУРЫ	ZAWIESZENIE ПОДВЕС	ZAWIESZENIE + KLOSZ ПОДВЕС + АБАЖУРЫ	GOTOWE DO ZAMONTOWANIA ГОТОВ К МОНТАЖУ
			
			
			
			

CAMELEON POSSIBILITIES

CANOPY A

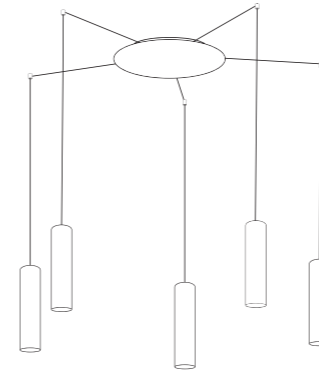

CANOPY B

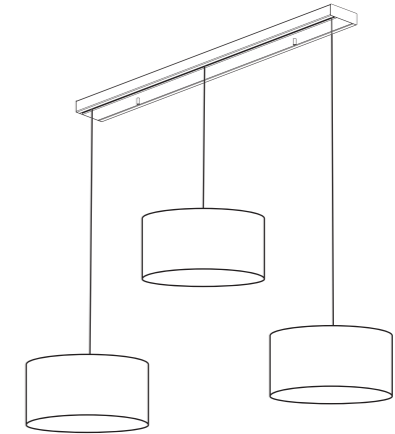

CANOPY C

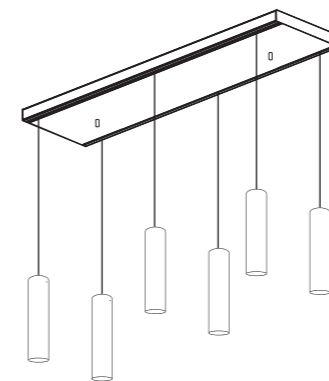

CANOPY D

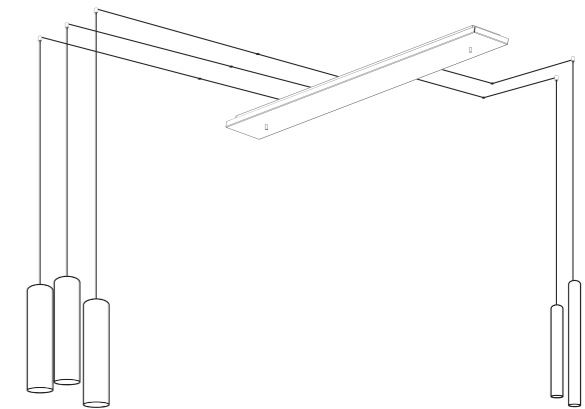

CANOPY E

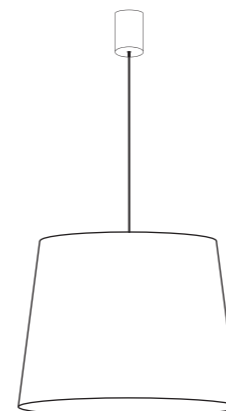

CANOPY F

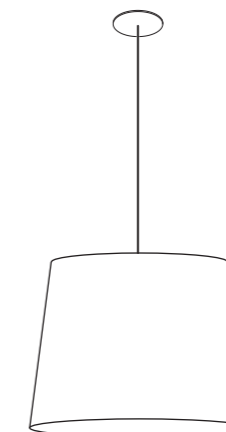

CANOPY G



CANOPY A

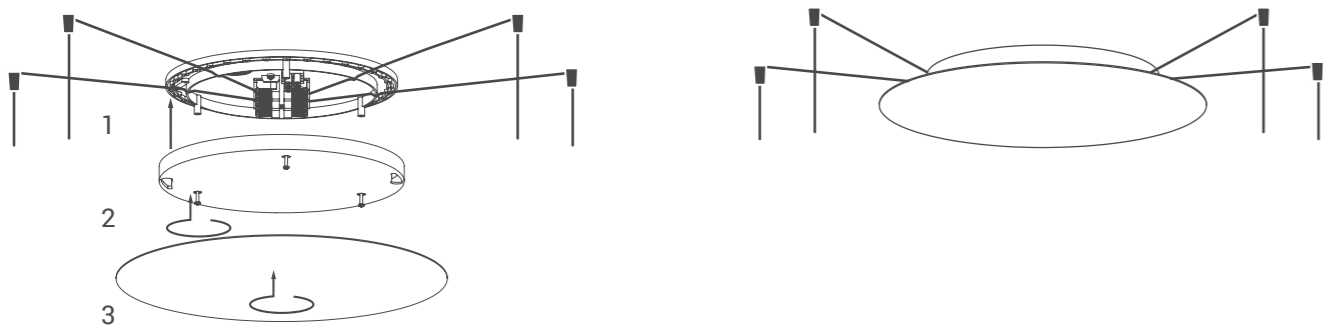
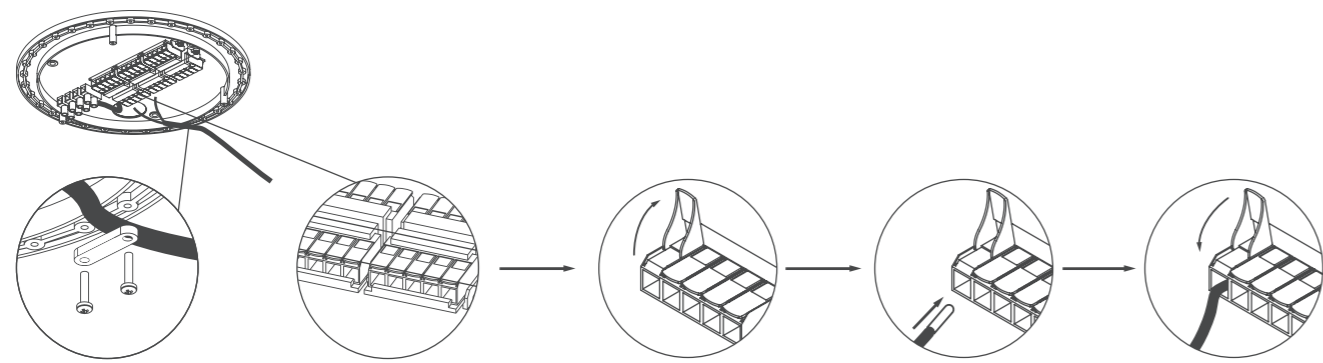
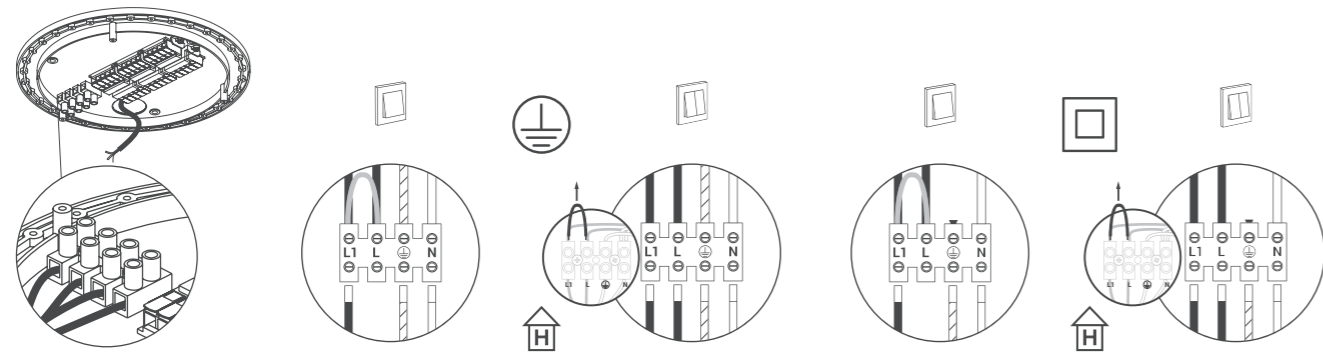
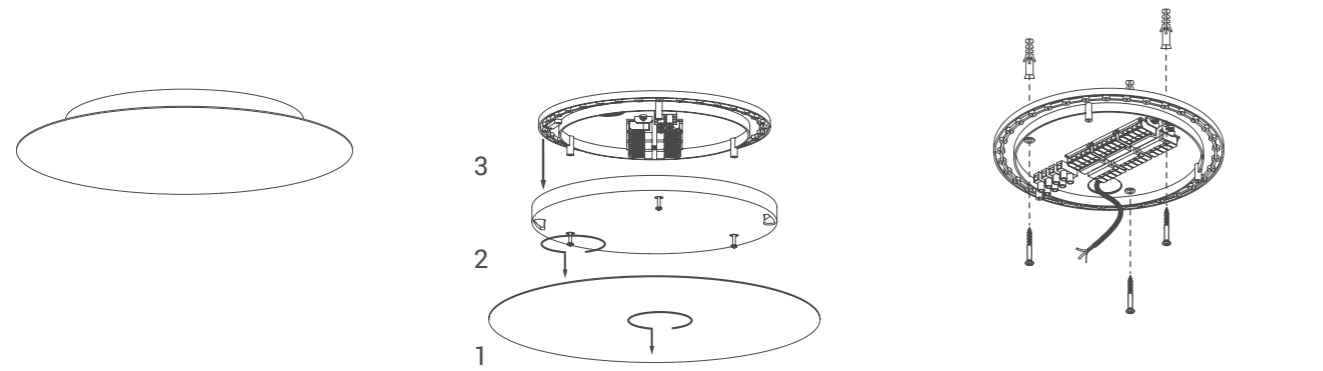

ZONES CANOPY A

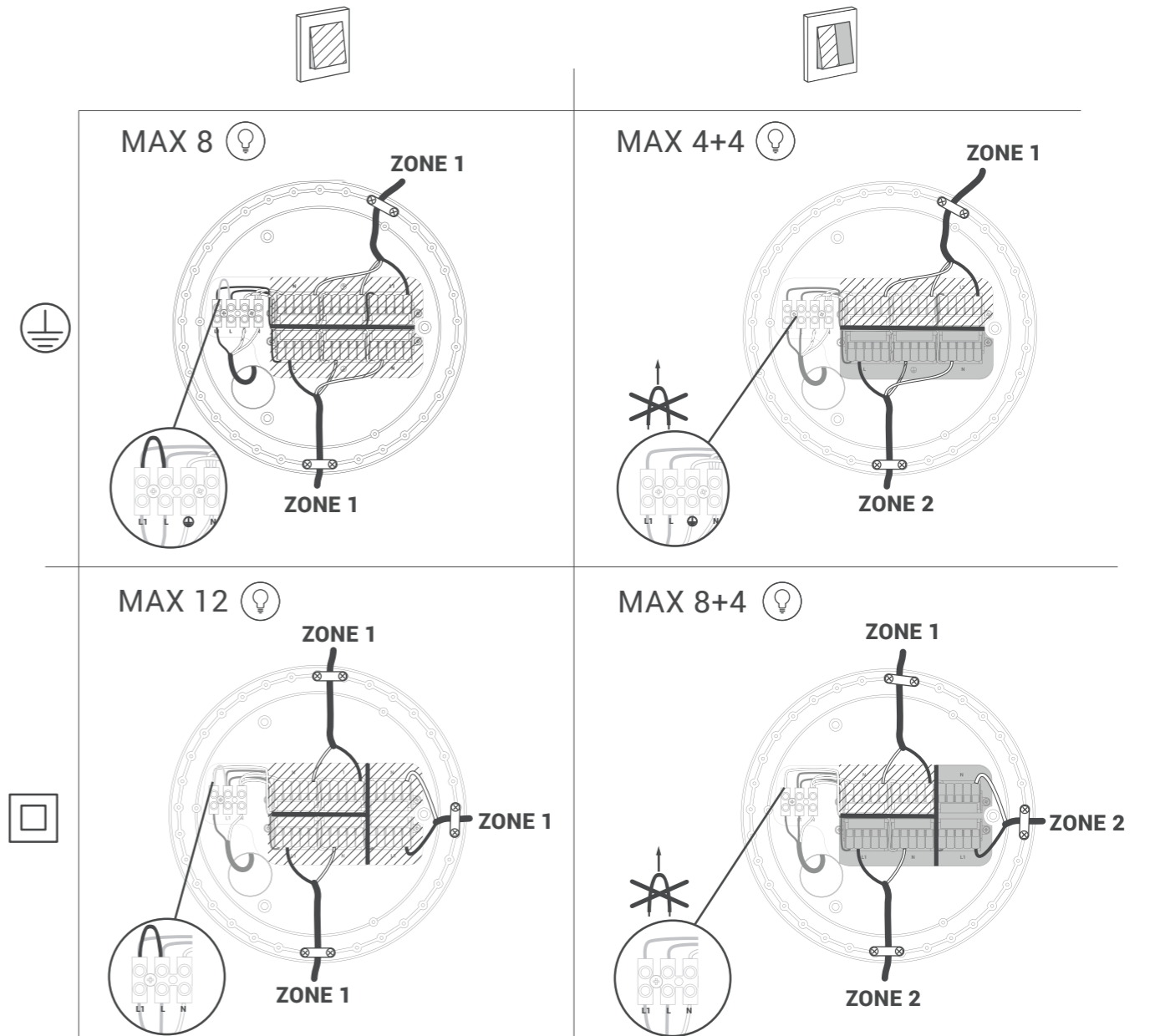
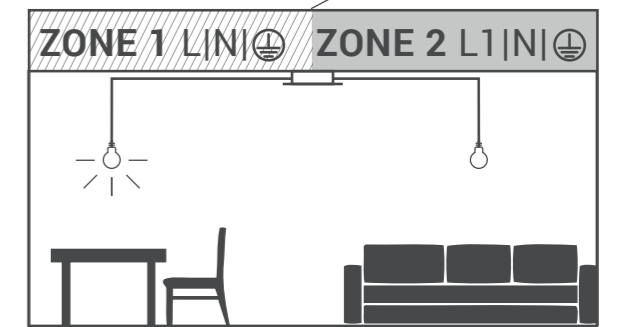
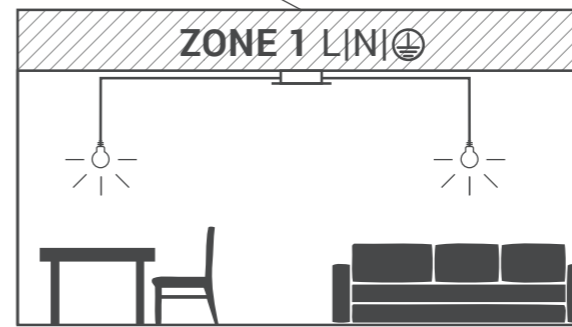

CANOPY B, C, D

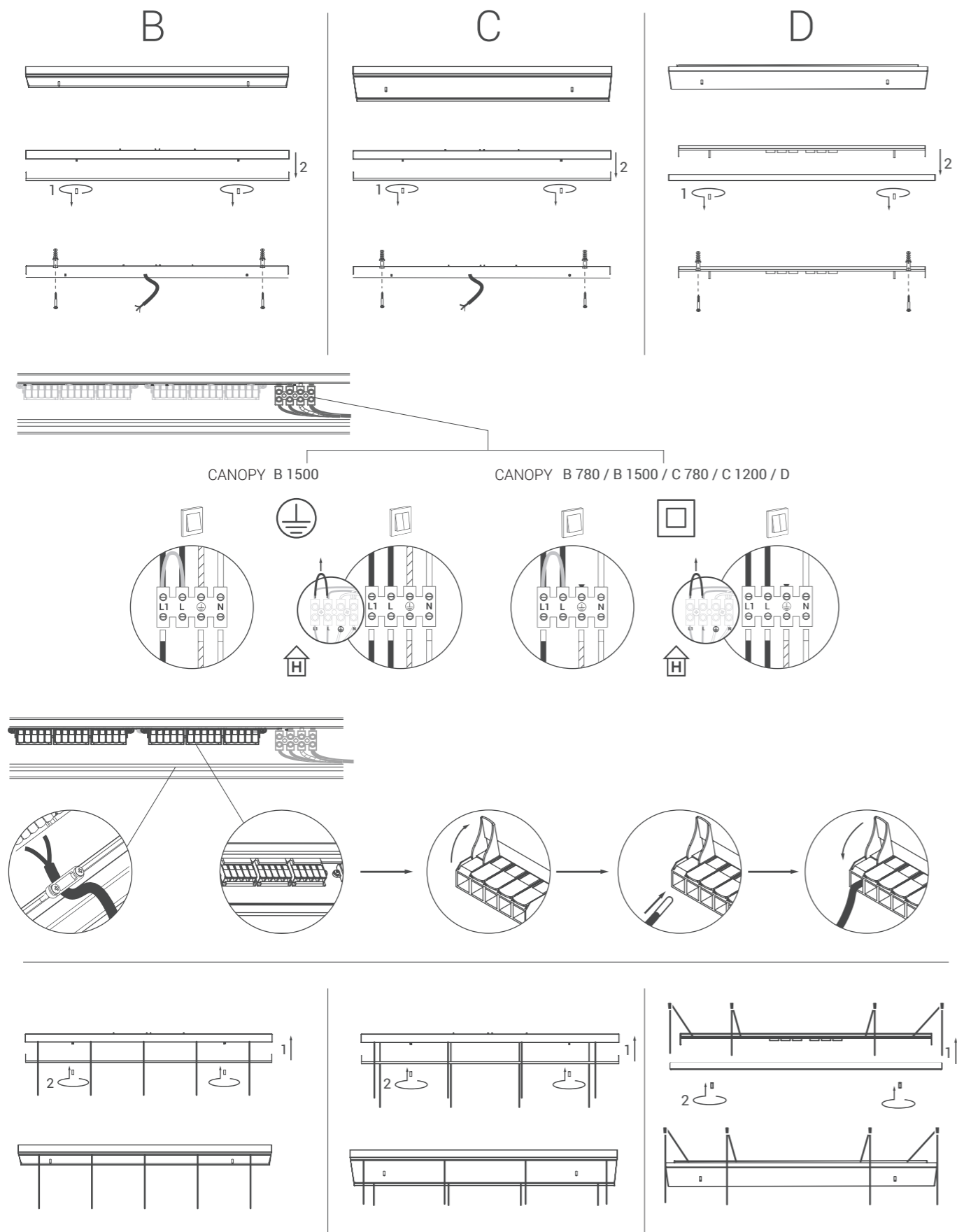

ZONES CANOPY B, C, D

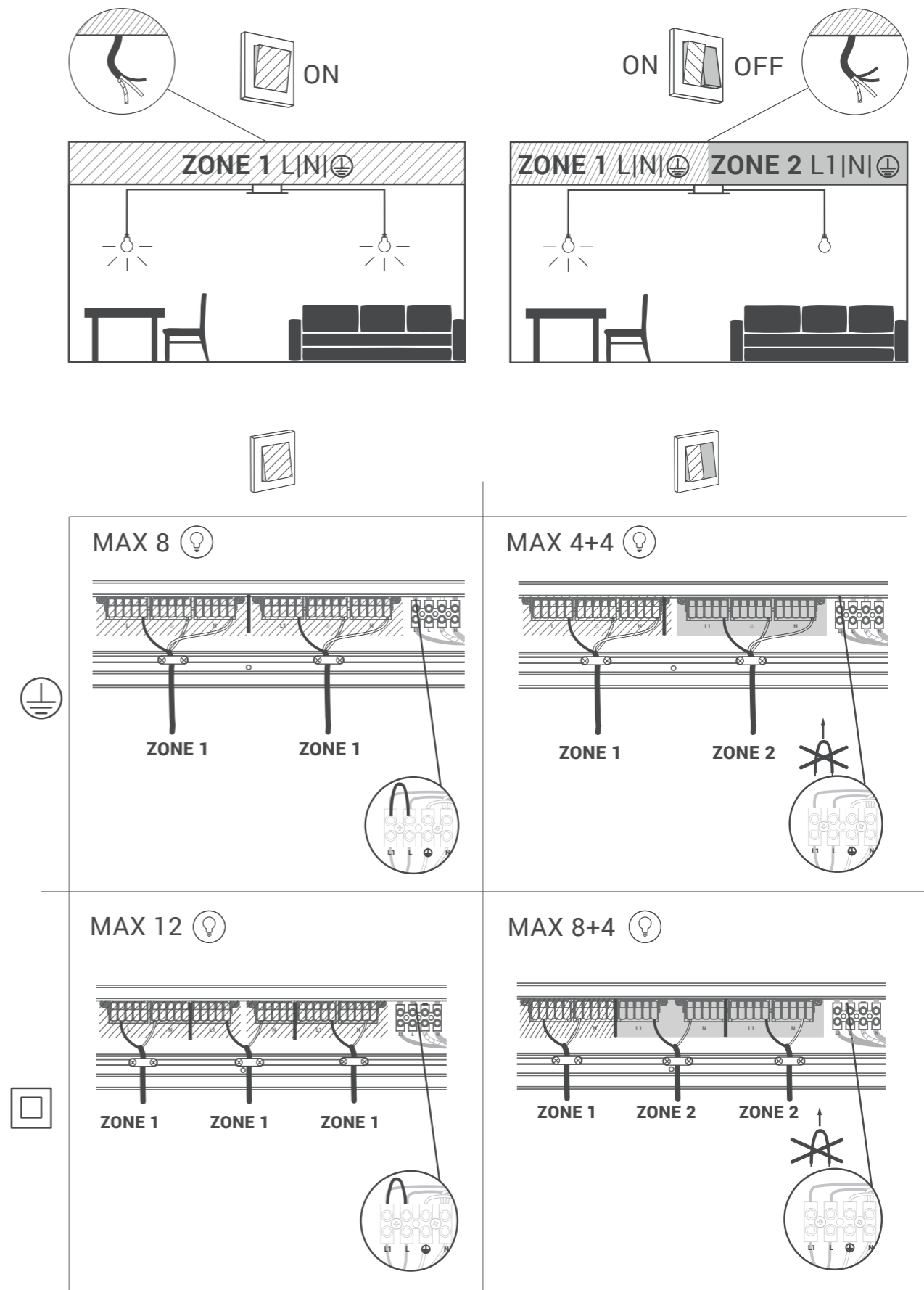

CANOPY E

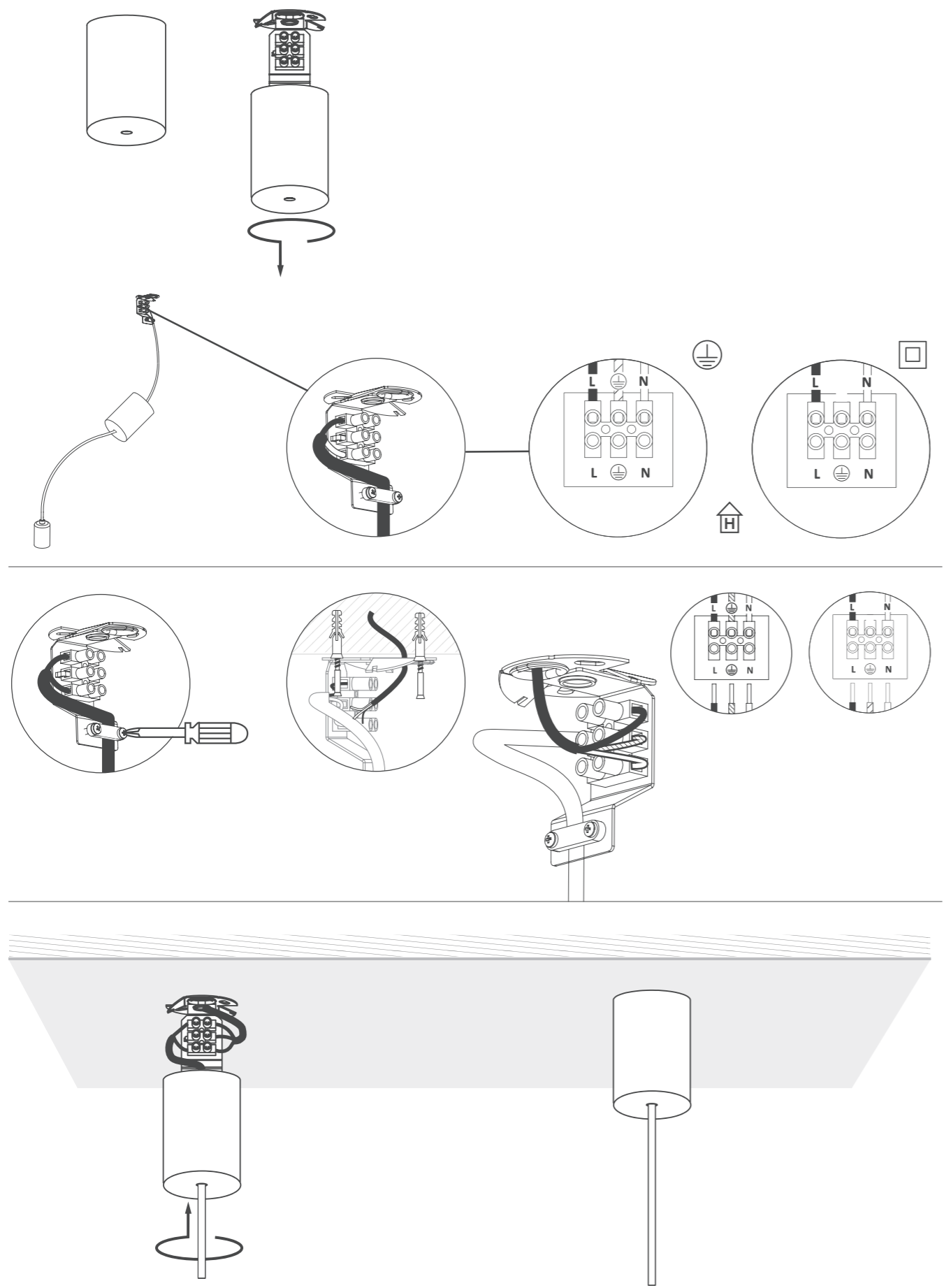

CANOPY F

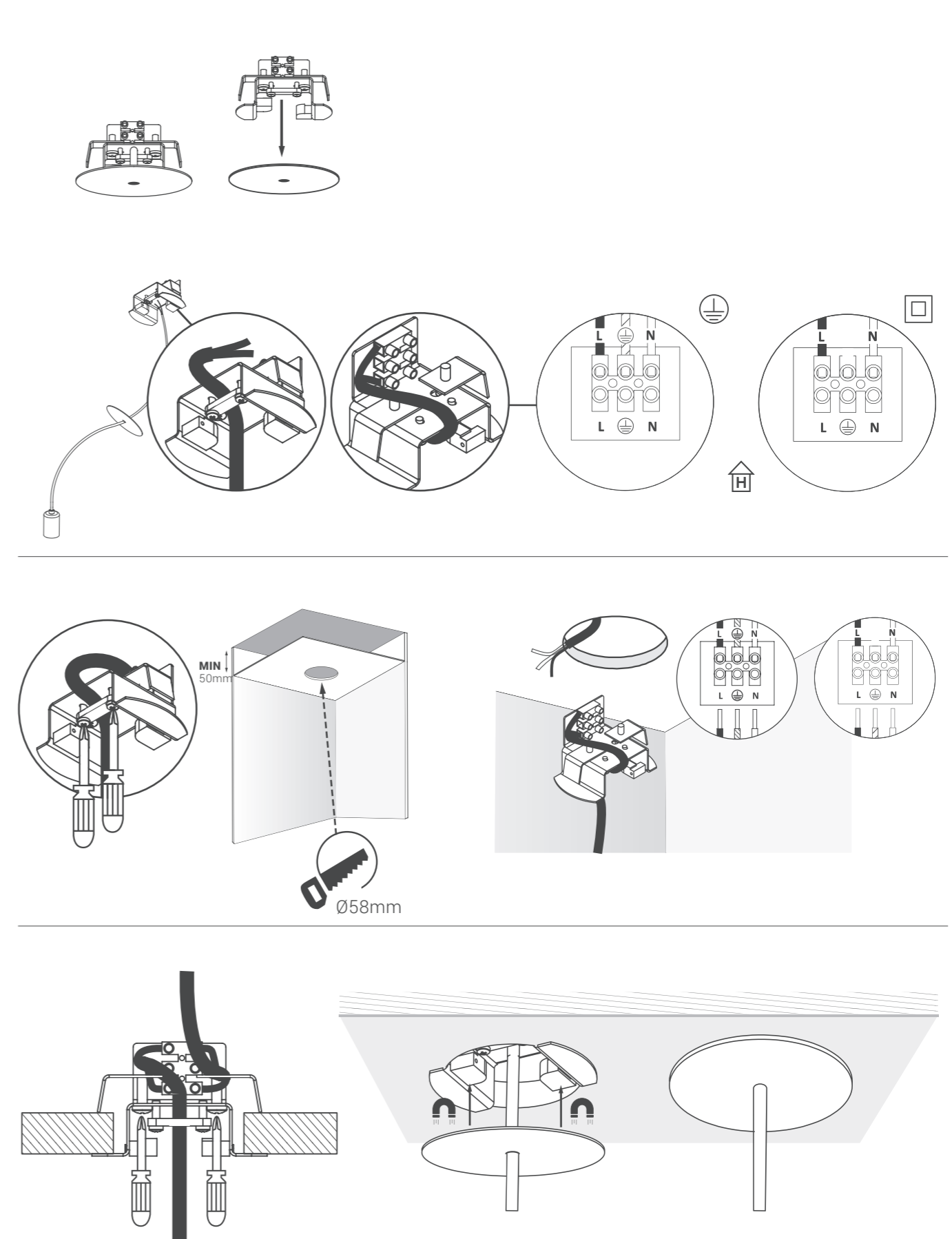

CANOPY G

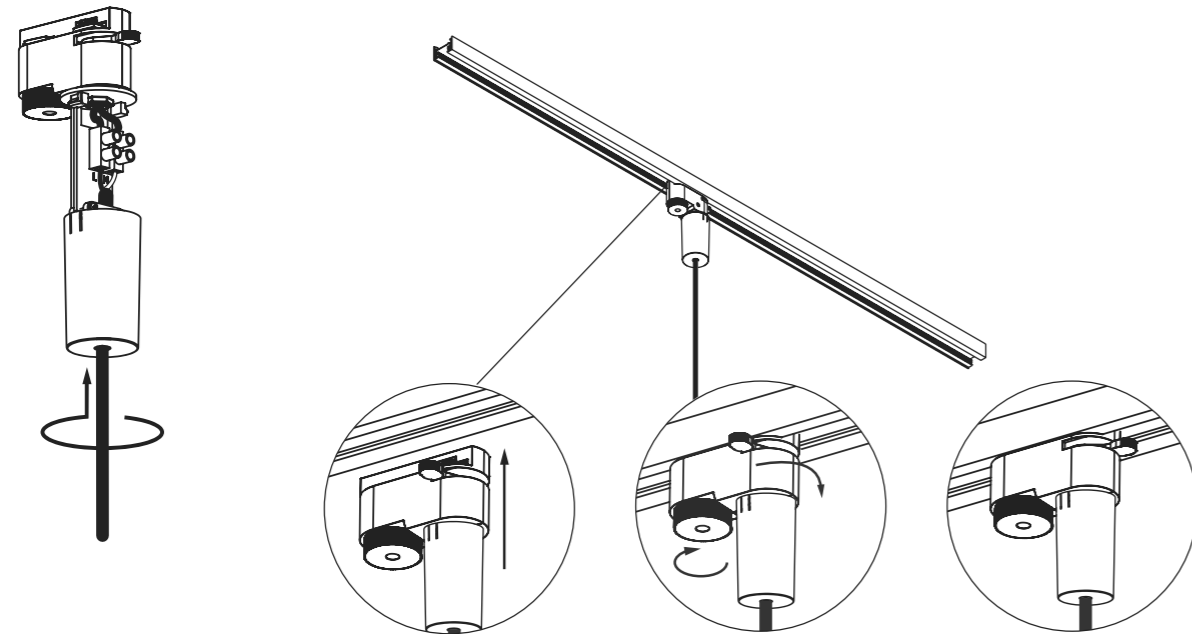
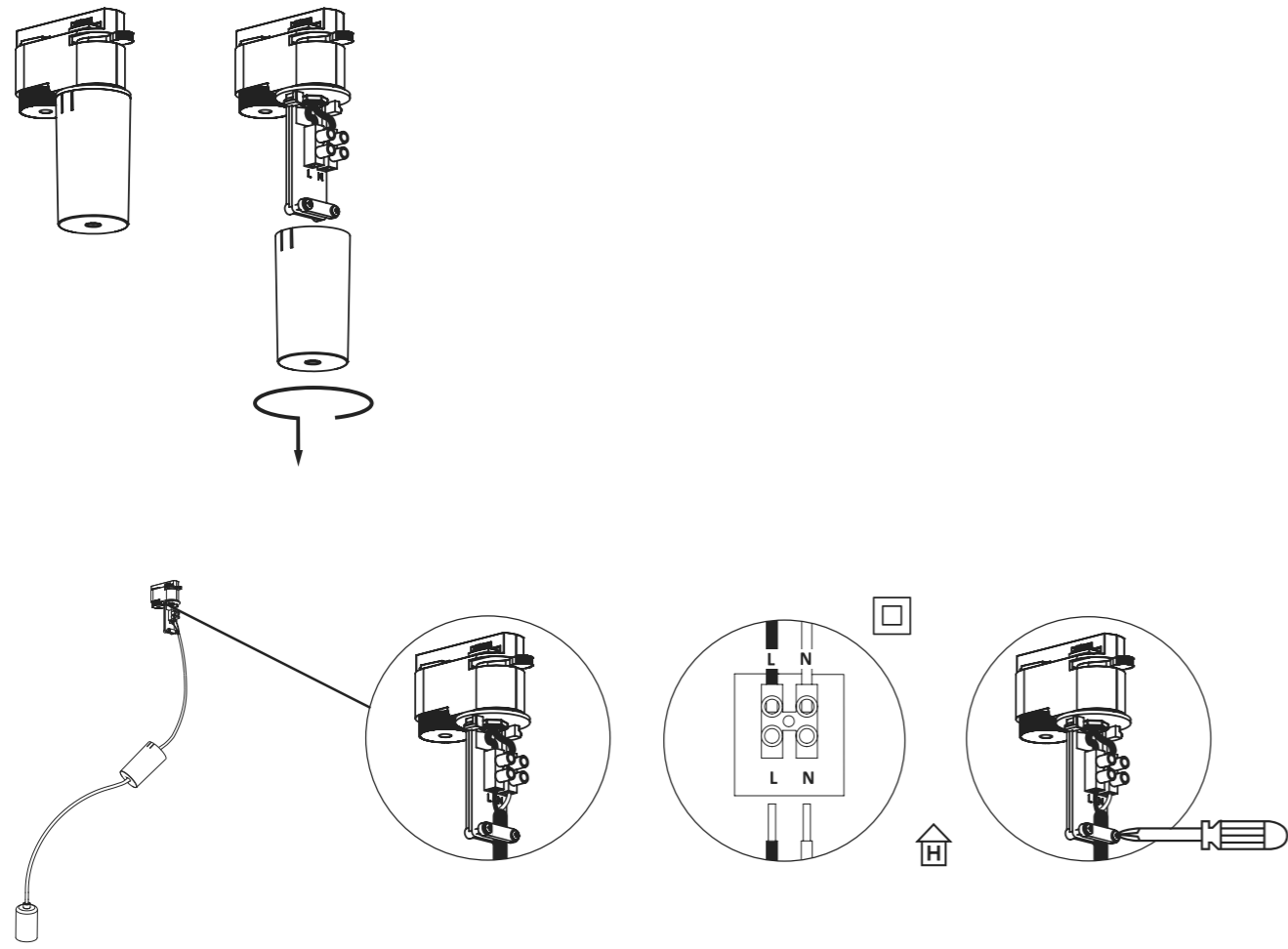

MOUNTING A, B, C

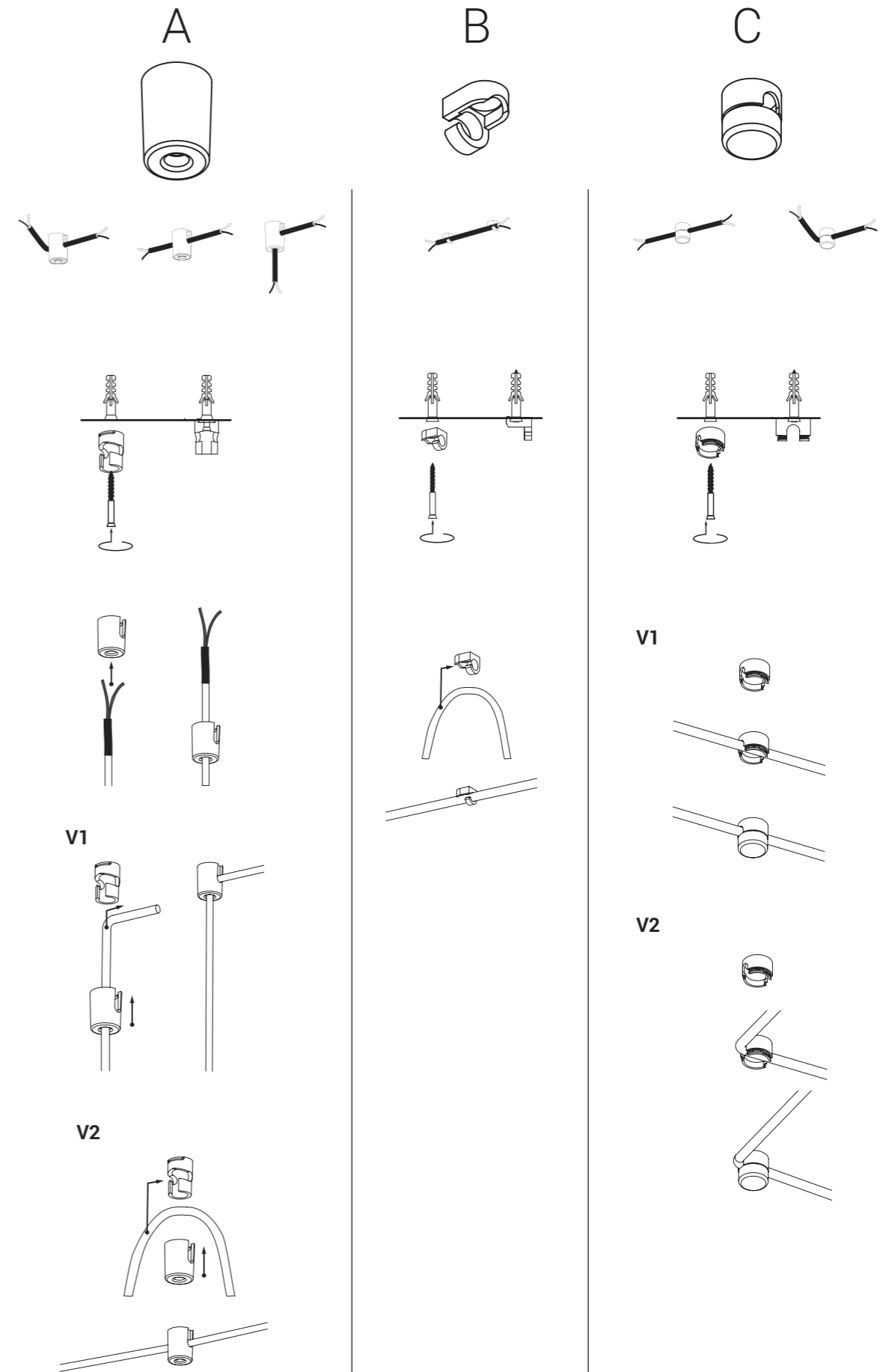

ALPHABETICAL INDEX / ALFABETYCZNY SPIS TREŚCI

A	G
ABI L 23	GEOMETRIC A 35
ABI M 23	GEOMETRIC B 35
ABI S 23	GEOMETRIC C 35
A LED 66	GSTAR 25
B	H
BARREL L 60	H LED 63
BARREL THIN S 59	
BARREL WIDE S 58	L
BIO M 46	LASER 490 28
BIO S 46	LASER 750 28
C	LASER 1000 28
CABLE E27 68	LUKSOR L 21
CABLE G9 68	LUKSOR S 21
CABLE GU10 68	M
CANOPY A 69	MOUNTING A 73
CANOPY B 780 70	MOUNTING B 73
CANOPY B 1500 70	MOUNTING C 73
CANOPY C 780 71	P
CANOPY C 1200 71	PEAR L 43
CANOPY D 780 69	PEAR M 43
CANOPY E 72	PEAR S 43
CANOPY F 72	PICO A 22
CANOPY G 72	PICO B 22
CONE L 53	PICO C 22
CONE M 52	POLY L 32
CONE S 54	POLY M 32
CYLINDER L 38	Q
CYLINDER M 38	Q LED 67
CYLINDER S 38	S
D	SPHERE L 44
DOVER 47	SPHERE M 44
E	SPHERE S 44
EGG M 26	
EYE L 30-31	
EYE M 30-31	

SPHERE XL 44	U
STRAW M 39	UMBRELLA 25
STRAW S 39	W
T	WAVE L 19
TULUM 33	WAVE S 19
	WHEEL 48























PROGRESSIVE CODE INDEX / INDEKS LAMP

INDEX	PAGE/STRONA	INDEX	PAGE/STRONA	INDEX	PAGE/STRONA	INDEX	PAGE/STRONA
8360	72	8451	66	8491	53	8525	59
8361	72	8452	67	8492	53	8526	59
8393	73	8453	67	8493	53	8527	44
8394	73	8454	63	8494	53	8528	44
8395	73	8455	63	8495	52	8530	44
8396	73	8457	46	8496	52	8531	44
8400	39	8458	46	8497	52	8532	43
8401	39	8461	46	8498	52	8533	43
8402	39	8462	46	8500	54	8534	43
8403	39	8463	47	8501	54	8535	39
8405	73	8464	47	8502	54	8536	39
8406	53	8465	35	8503	54	8537	38
8407	53	8466	35	8504	54	8538	38
8408	53	8467	33	8505	54	8540	38
8410	53	8471	32	8506	60	8541	38
8411	52	8472	32	8507	60	8542	38
8412	52	8473	32	8508	60	8543	38
8413	52	8474	32	8510	60	8544	38
8414	52	8475	31	8511	60	8545	38
8415	54	8476	31	8512	58	8546	38
8416	54	8477	31	8513	58	8547	72
8417	60	8478	31	8514	58	8548	72
8418	60	8480	31	8515	58	8550	72
8420	60	8481	31	8516	58	8551	72
8421	58	8482	31	8517	58	8552	69
8422	59	8483	31	8518	58	8553	69
8423	48	8484	30	8520	59	8554	71
8424	48	8485	30	8521	59	8555	71
8425	35	8486	28	8522	59	8556	71
8426	33	8487	28	8523	59	8557	71
8450	66	8488	28	8524	59	8558	70

INDEX	PAGE/STRONA	INDEX	PAGE/STRONA	INDEX	PAGE/STRONA	INDEX	PAGE/STRONA
8560	70	8587	23	8615	68	8643	68
8561	70	8588	22	8616	68	8644	68
8562	70	8590	22	8617	68	8645	68
8563	69	8591	22	8618	68	8646	68
8564	69	8592	21	8620	68	8647	68
8565	69	8593	21	8621	68	8648	68
8566	69	8594	68	8622	68	8650	68
8567	28	8595	68	8623	68	8651	68
8568	28	8596	21	8624	68	8652	68
8570	28	8597	21	8625	68	8653	68
8571	28	8598	68	8626	68	8654	68
8572	28	8600	19	8627	68	8655	68
8573	28	8601	68	8628	68	8656	68
8574	25	8602	19	8630	68	8657	68
8575	25	8603	19	8631	68	8658	68
8576	25	8604	19	8632	68	8660	68
8577	23	8605	19	8633	68	8661	68
8578	68	8606	19	8634	68	8662	68
8580	68	8607	26	8635	68	8663	68
8581	23	8608	70	8636	68	8664	68
8582	23	8610	70	8637	68	8665	68
8583	68	8611	68	8638	68	8666	68
8584	23	8612	68	8640	68	8667	68
8585	68	8613	68	8641	68	8668	68
8586	23	8614	68	8642	68	8670	68

NOTATKI

COLOR CODES / KODY KOLORÓW

- | | | |
|---|---|--|
|  WH - WHITE |  BL - BLACK |  WH/CH - WHITE/CHROME |
|  V WH - VELVET WHITE |  V BL - VELVET BLACK |  BL/CH - BLACK/CHROME |
|  TR - TRANSPARENT |  TR/BL - TRANSPARENT/BLACK |  BL/BS - BLACK/BRASS |
|  TR/WH - TRANSPARENT/WHITE |  BS - BRASS |  BL/G - BLACK/GOLD |
|  SI - SILVER |  G - GOLD |  V NB/G - VELVET NAVI BLUE/GOLD |
|  GY - GRAY |  NT - NATURAL |  V GN/G - VELVET GREEN/GOLD |
|  CN - CONCRETE |  TR/G - TRANSPARENT/GOLD |  V PI/WH - VELVET PINK/WHITE |
|  GR - GRAPHITE |  TR/BS - TRANSPARENT/BRASS | |

Nowodvorski

L I G H T I N G

Nowodvorski sp.j.

 ul. Bojemskiego 11
42-202 Częstochowa
POLAND

 +48 34 344 91 10 / 11

 +48 34 344 91 12

 nowodvorski@nowodvorski.com

 www.nowodvorski.com



Design & production

GRAFFITI
CREATIVE PEOPLE

www.graffiti.com.pl

Nowodvorski

L I G H T I N G

Nowodvorski sp.j.
ul. Bojemskiego 11
42-202 Częstochowa
POLAND

 +48 34 344 91 10/11

 nowodvorski@nowodvorski.com



www.nowodvorski.com