

Nowoczesna technika budowlana
thermodom[®]

**Przedsiębiorstwo Produkcyjno-Usługowo-Handlowe
Sp. z o.o.
44-240 Żory ul. Boczna 6**

www.thermodom.pl

biuro@thermodom.pl

Program produkcji

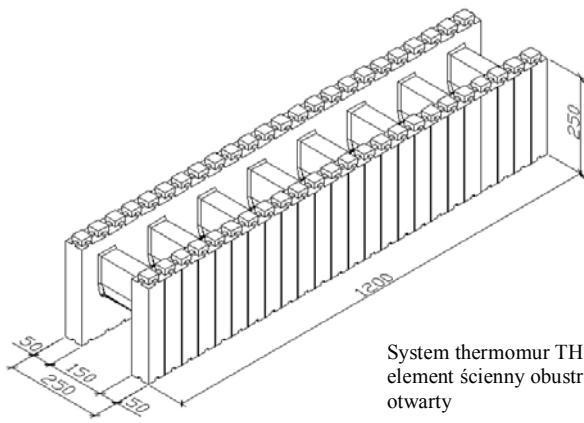
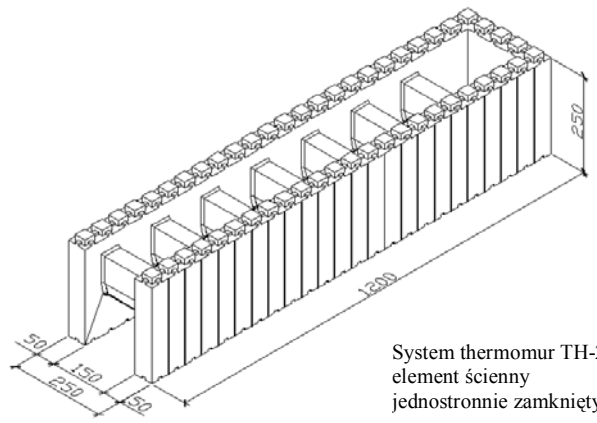
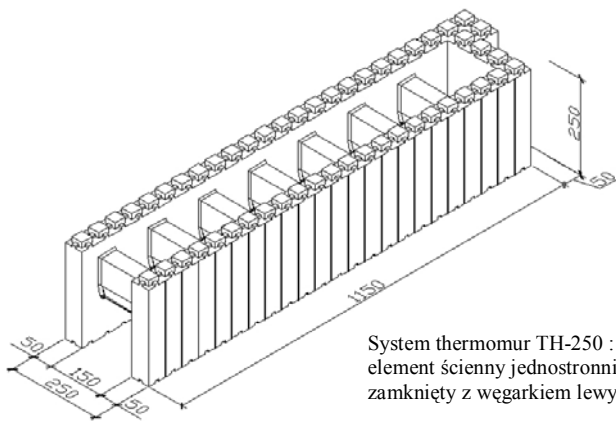
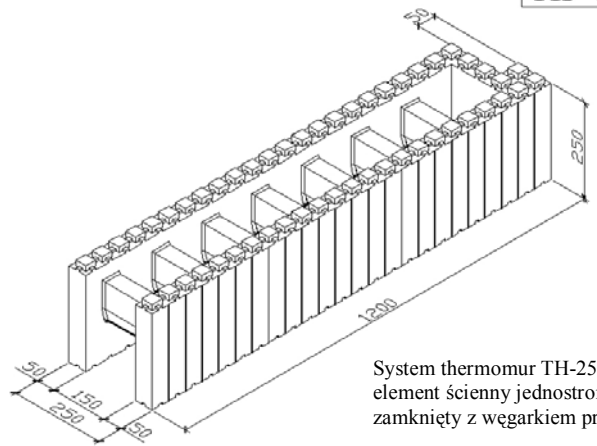
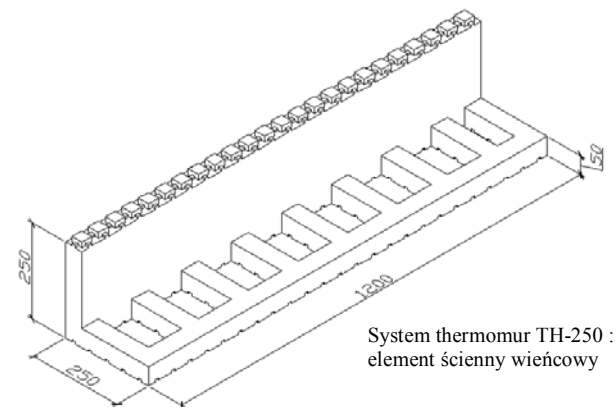
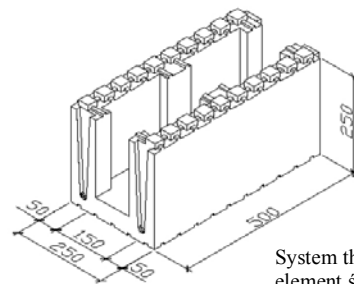
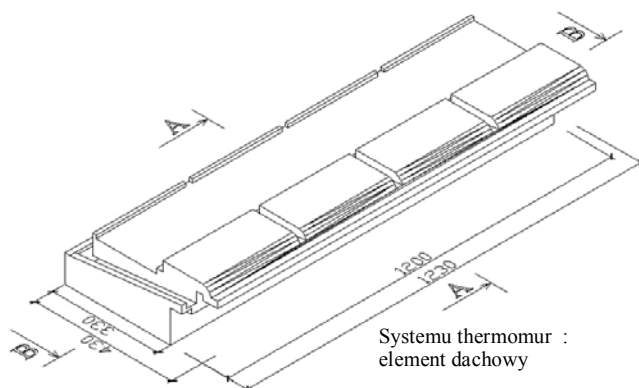
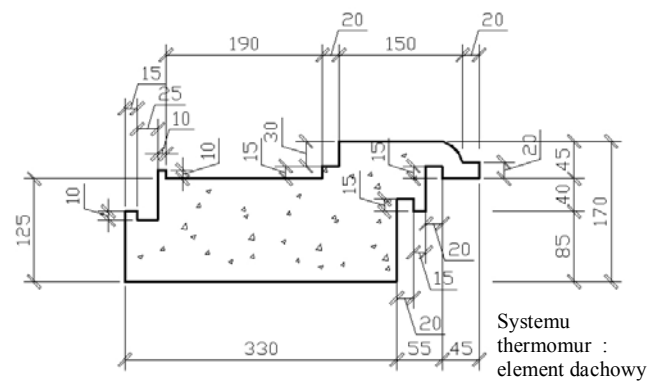
TH - 1System thermomur TH-250 :
element ścienny obustronnie
otwarty**TH - 2**System thermomur TH-250 :
element ścienny
jednostronnie zamknięty**TH - 2L**System thermomur TH-250 :
element ścienny jednostronnie
zamknięty z węgarciem lewy**TH - 2P**System thermomur TH-250 :
element ścienny jednostronnie
zamknięty z węgarciem prawy**TH - 3**System thermomur TH-250 :
element ścienny wieńcowy**TH - 4**System thermomur TH-250 :
element ścienny nadprożowy**TH - 7**Systemu thermomur :
element dachowy**TH - 7 przekrój A-A**Systemu
thermomur :
element dachowy

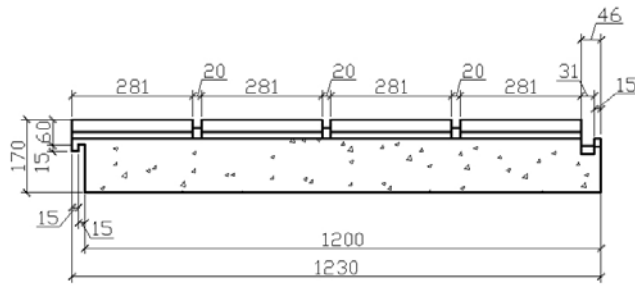
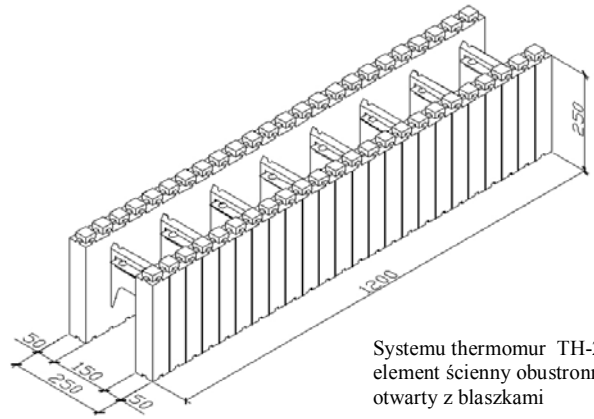
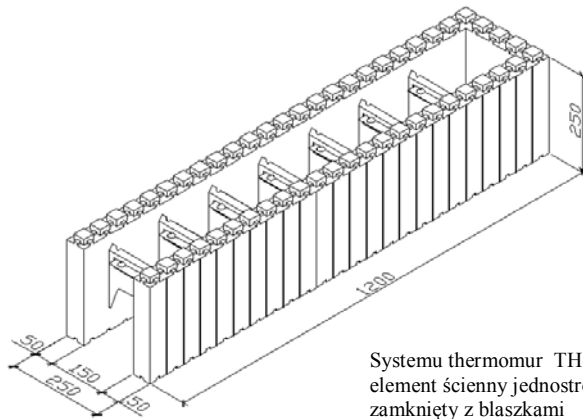
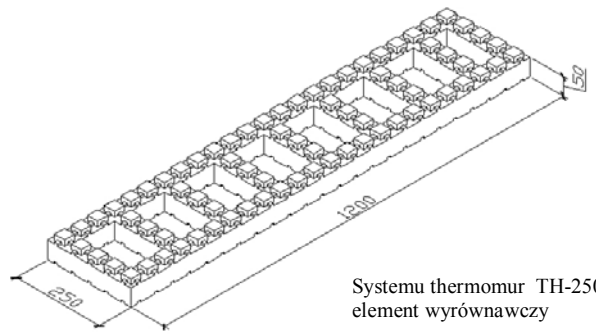
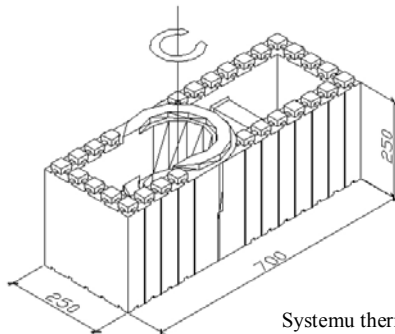
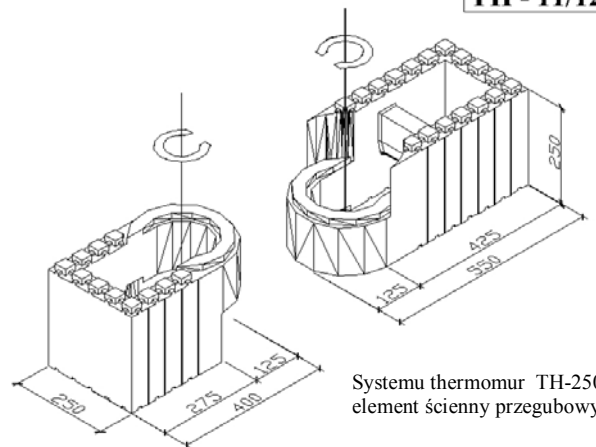
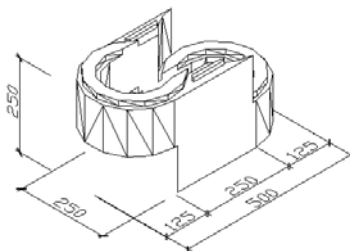
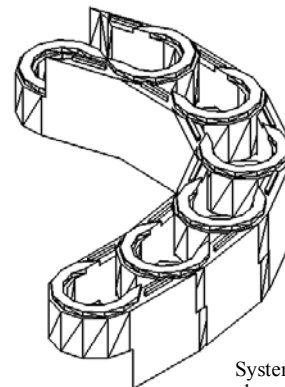
TH - 7 przekrój B-BSystemu thermomur :
element dachowy**TH - 8**Systemu thermomur TH-250 :
element ścienny obustronnie
otwarty z blaszkami**TH - 9**Systemu thermomur TH-250 :
element ścienny jednostronnie
zamknięty z blaszkami**TH - 10**Systemu thermomur TH-250 :
element wyrównawczy**TH - 11/12**Systemu thermomur TH-250 :
element ścienny przegubowy**TH - 11/12**Systemu thermomur TH-250 :
element ścienny przegubowy**TH - 13**Systemu thermomur TH-250 :
element ścienny dodatkowy**TH - 13**Systemu thermomur TH-250 :
element ścienny dodatkowy

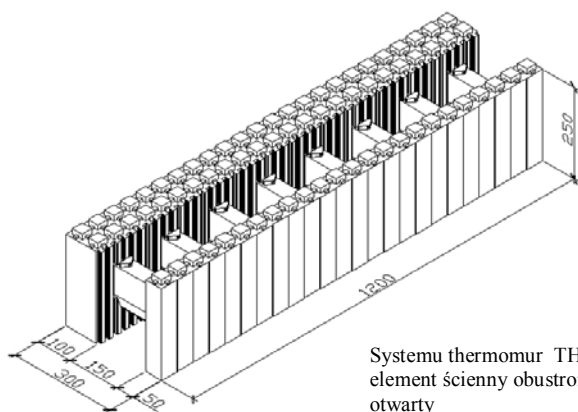
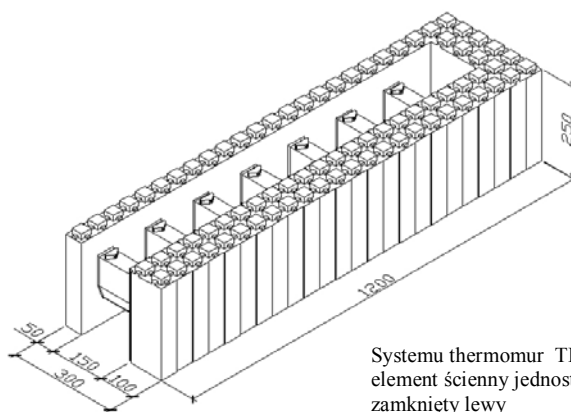
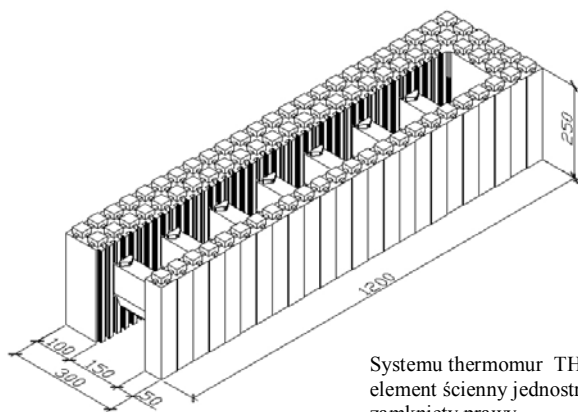
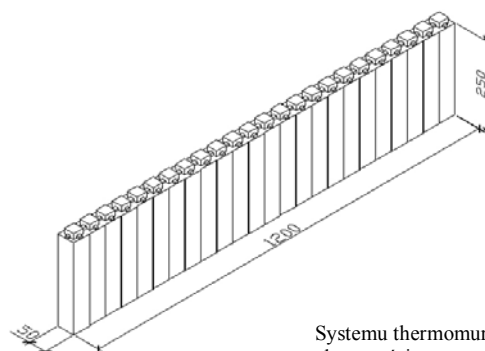
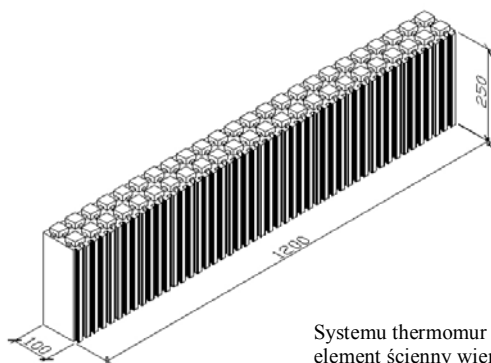
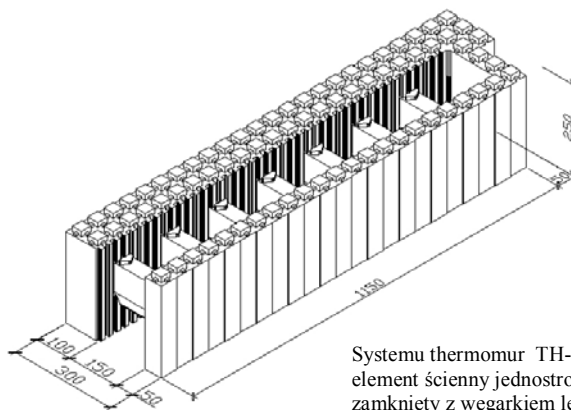
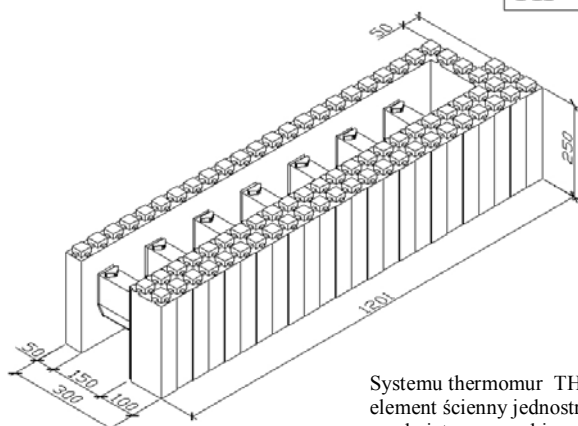
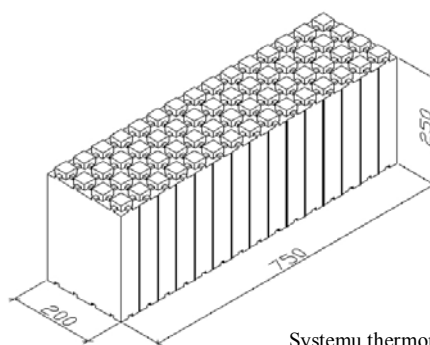
TH - 14Systemu thermomur TH-300 :
element ścienny obustronnie
otwarty**TH - 15L**Systemu thermomur TH-300 :
element ścienny jednostronnie
zamknięty lewy**TH - 15P**Systemu thermomur TH-300 :
element ścienny jednostronnie
zamknięty prawy**TH - 16**Systemu thermomur TH-300 :
element ścienny uzupełniający**TH - 17**Systemu thermomur TH-300 :
element ścienny wieńcowy**TH - 18L**Systemu thermomur TH-300 :
element ścienny jednostronnie
zamknięty z węgarkiem lewy**TH - 18P**Systemu thermomur TH-300 :
element ścienny jednostronnie
zamknięty z węgarkiem prawy**TH - 19**Systemu thermomur TH-400 :
element ścienny wieńcowy

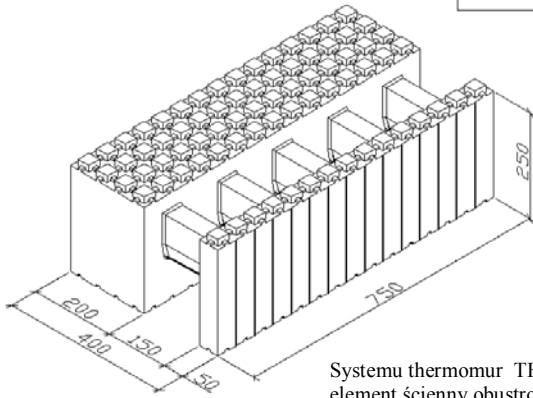
TH - 20

Systemu thermomur TH-400 :
element ścienny obustronnie
otwarty

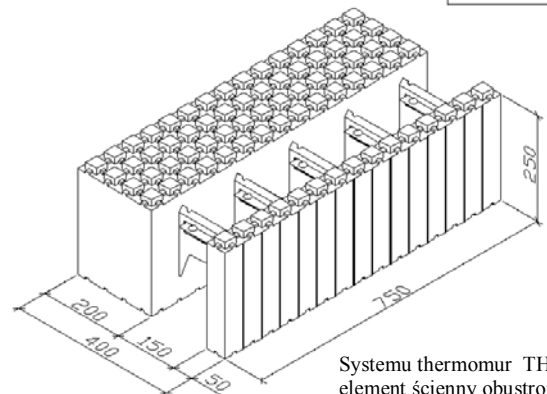
TH - 20/B

Systemu thermomur TH-400 :
element ścienny obustronnie
otwarty z blaszkami

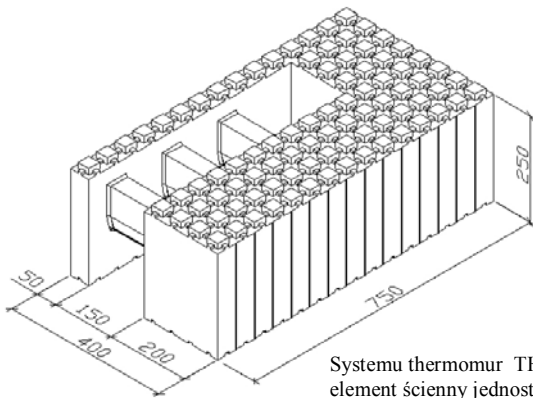
TH - 21L

Systemu thermomur TH-400 :
element ścienny jednostronnie
zamknięty lewy

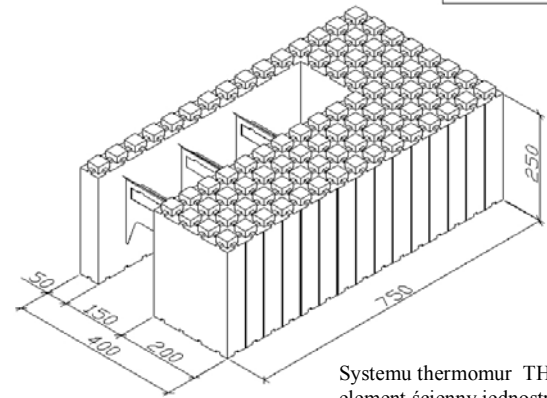
TH - 21L/B

Systemu thermomur TH-400 :
element ścienny jednostronnie
zamknięty lewy z blaszkami

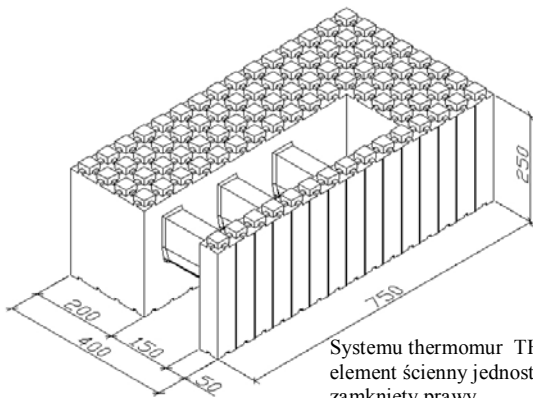
TH - 21P

Systemu thermomur TH-400 :
element ścienny jednostronnie
zamknięty prawy

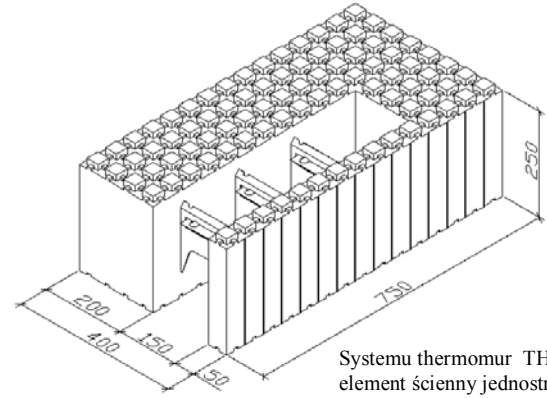
TH - 21P/B

Systemu thermomur TH-400 :
element ścienny jednostronnie
zamknięty prawy z blaszkami

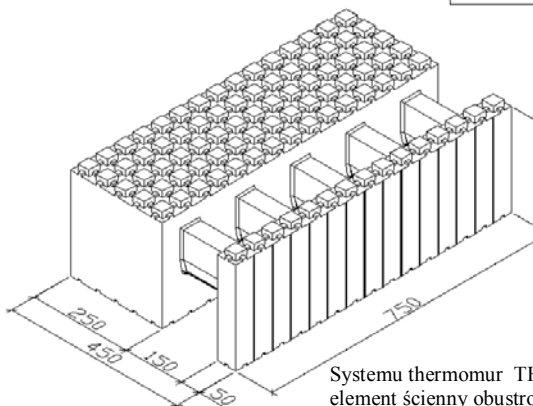
TH - 22

Systemu thermomur TH-450 :
element ścienny obustronnie
otwarty

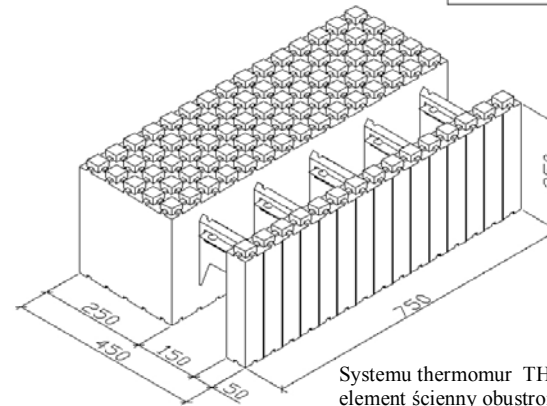
TH - 22/B

Systemu thermomur TH-450 :
element ścienny obustronnie
otwarty z blaszkami

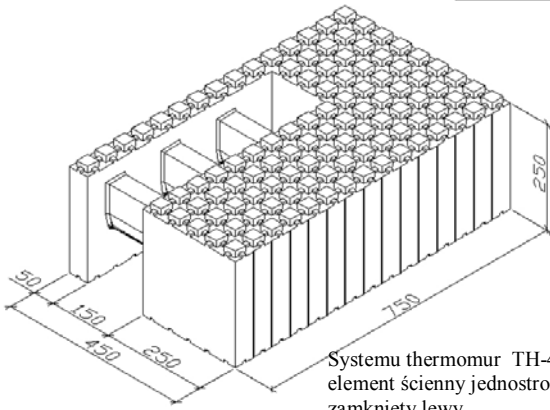
TH - 23L

Systemu thermomur TH-450 :
element ścienny jednostronnie
zamknięty lewy

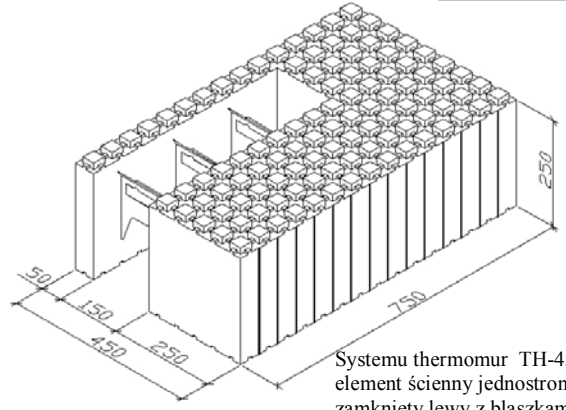
TH - 23L/B

Systemu thermomur TH-450 :
element ścienny jednostronnie
zamknięty lewy z blaszkami

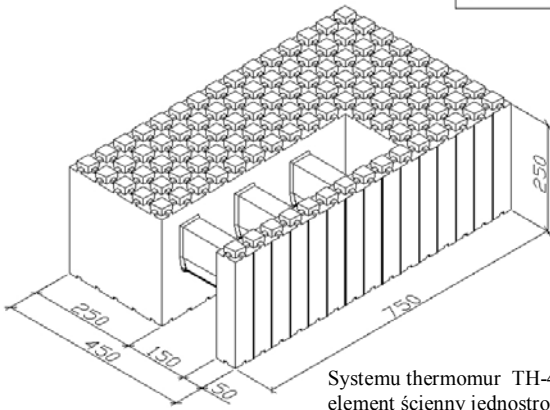
TH - 23P

Systemu thermomur TH-450 :
element ścienny jednostronnie
zamknięty prawy

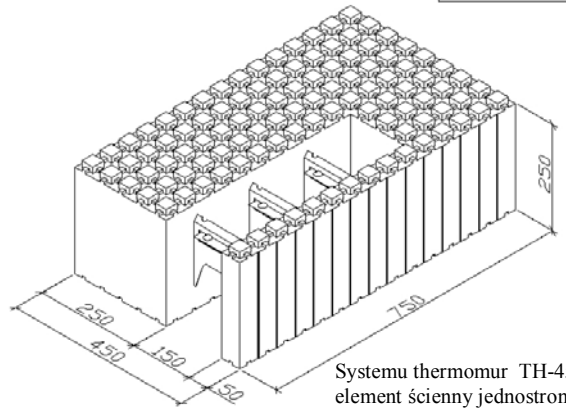
TH - 23P/B

Systemu thermomur TH-450 :
element ścienny jednostronnie
zamknięty prawy z blaszkami

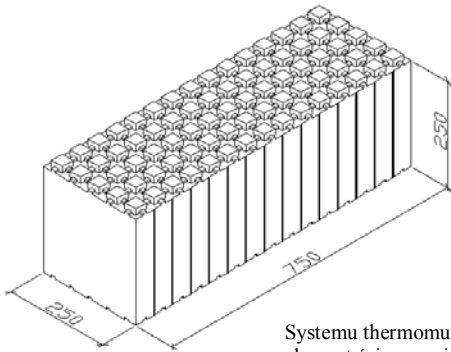
TH - 24

Systemu thermomur TH-450 :
element ścienny wieńcowy

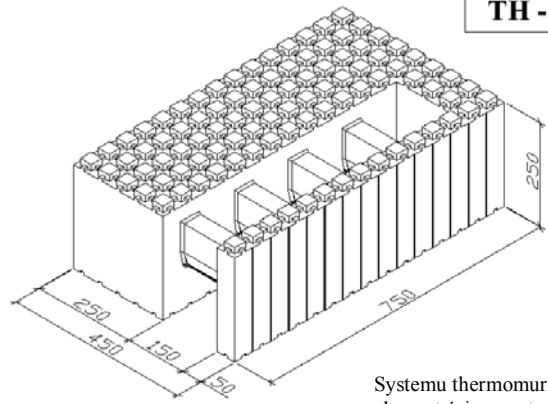
TH - 25L

Systemu thermomur TH-450 :
element ścienny otworowy
lewy

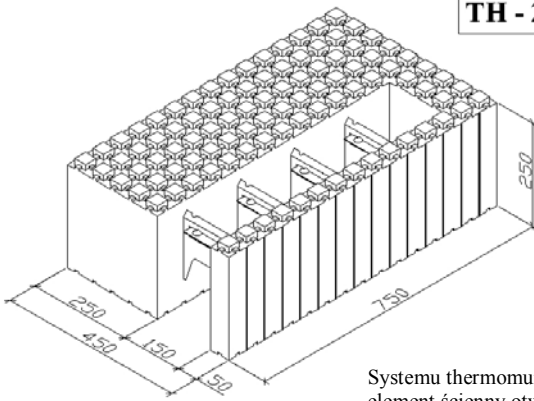
TH - 25L/B

Systemu thermomur TH-450 :
element ścienny otworowy
lewy z blaszkami

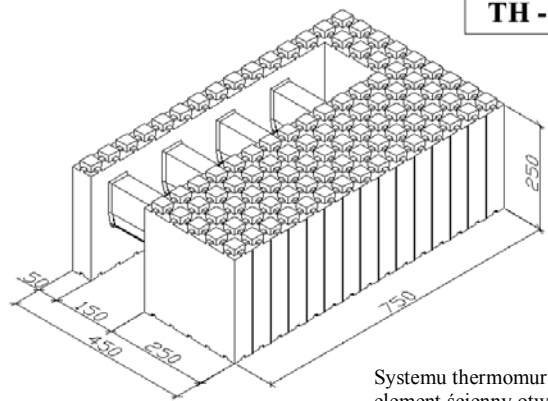
TH - 25P

Systemu thermomur TH-450 :
element ścienny otworowy
prawy z blaszkami

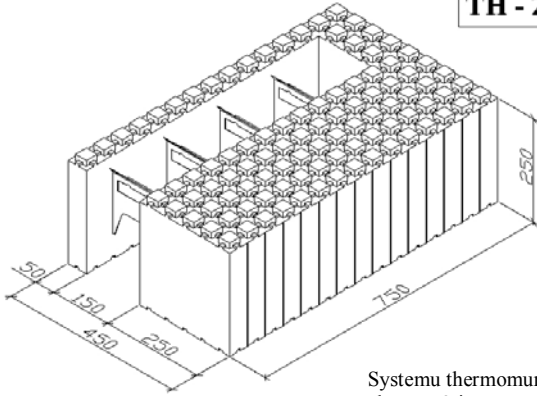
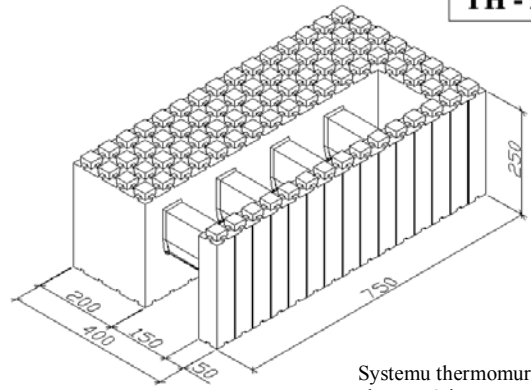
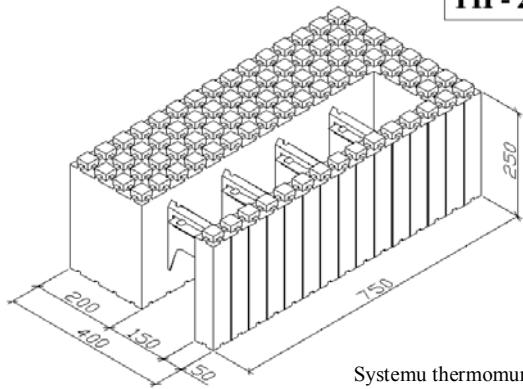
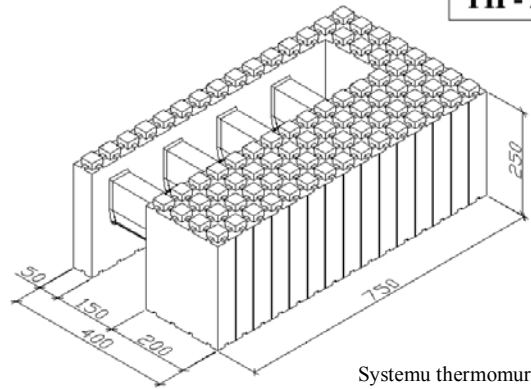
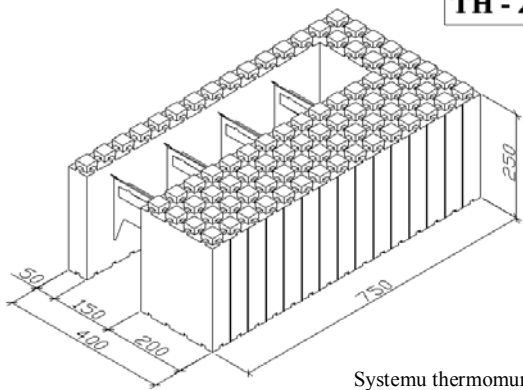
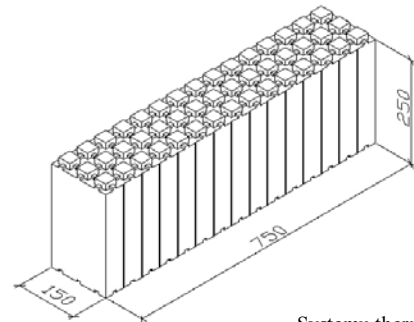
TH - 25P/BSystemu thermomur TH-450 :
element ścienny otworowy
prawy z blaszkami**TH - 26L**Systemu thermomur TH-400 :
element ścienny otworowy
lewy**TH - 26L/B**Systemu thermomur TH-400 :
element ścienny otworowy
lewy z blaszkami**TH - 26P**Systemu thermomur TH-400 :
element ścienny otworowy
prawy**TH - 26P/B**Systemu thermomur TH-400 :
element ścienny otworowy
prawy z blaszkami**TH - 27**Systemu thermomur TH-400 :
element ścienny dodatkowy